

myprojectorlamps.com

**The most trusted, dependable name
in projector lamp sales.**



<http://www.myprojectorlamps.com>



<http://www.myprojectorlamps.ca>



<http://www.myprojectorlamps.eu>

The following projector manual has not been modified or altered in any way.

HITACHI

Inspire the Next

LCD REAR PROJECTION TELEVISION

Operating Guide for 50VS69A 55VS69A and 62VS69A

IMPORTANT SAFETY INSTRUCTIONS.....	2-3
FIRST TIME USE	4-18
THE REMOTE CONTROL	19-30
ON-SCREEN DISPLAY	31-55
LAMP REPLACEMENT	56-59
USEFUL INFORMATION.....	60-64
LICENSE AGREEMENT.....	65-73
APPENDIXES	74-75
INDEX	76



*As an Energy Star® Partner,
Hitachi, Ltd. has determined
that this product meets the
Energy Star® guidelines for
energy efficiency.*

Important Safety Instructions



SAFETY POINTS YOU SHOULD KNOW ABOUT YOUR HITACHI LCD REAR PROJECTION TELEVISION

Our reputation has been built on the quality, performance, and ease of service of **HITACHI** televisions.

Safety is also foremost in our minds in the design of these units. To help you operate these products properly, this section illustrates safety tips which will be of benefit to you. Please read it carefully and apply the knowledge you obtain from it to the proper operation of your **HITACHI** television.

Please fill out your warranty card and mail it to **HITACHI**. This will enable **HITACHI** to notify you promptly in the improbable event that a safety problem should be discovered in your product model.

Follow all warnings and instructions marked on this television.



 The lightning flash with arrowhead symbol, within an equilateral triangle, is intended to alert the user to the presence of uninsulated "dangerous voltage" within the product's enclosure that may be of a sufficient magnitude to constitute a risk of electric shock to a person.

 The exclamation point within an equilateral triangle, is intended to alert the user to the presence of important operating and maintenance (servicing) instructions in the literature accompanying the appliance.

READ BEFORE OPERATING EQUIPMENT

Follow all warnings and instructions marked on this television.

1. Read these instructions.
2. Keep these instructions.
3. Heed all warnings.
4. Follow all instructions.
5. Do not use this apparatus near water.
6. Clean only with a dry cloth.
7. Do not block any ventilation openings. Install in accordance with the manufacturer's instructions.
8. Do not install near any heat sources such as radiators, heat registers, stoves, or other apparatus (including amplifiers) that produce heat.
9. Do not defeat the safety purpose of the polarized or grounding-type plug. A polarized plug has two blades with one wider than the other. A grounding

type plug has two blades and a third grounding prong. The wide blade or the third prong are provided for your safety. If the provided plug does not fit into your outlet, consult an electrician for replacement of the obsolete outlet.

10. Protect the power cord from being walked on or pinched particularly at plugs, convenience receptacles, and the point where they exit from the apparatus.
11. Only use the attachments/accessories specified by the manufacturer.
12.  Use only with the cart, stand, tripod, bracket, or table specified by the manufacturer, or sold with the apparatus. When a cart is used, use caution when moving the cart/apparatus combination to avoid injury from tip-over.
13. Unplug this apparatus during lightning storms or when unused for long periods of time.
14. Refer all servicing to qualified service personnel. Servicing is required when the apparatus has been damaged in any way, such as power-supply cord or plug is damaged, liquid has been spilled or objects have fallen into apparatus, the apparatus has been exposed to rain or moisture, does not operate normally, or has been dropped.
15. Televisions are designed to comply with the recommended safety standards for tilt and stability. Do not apply excessive pulling force to the front, or top, of the cabinet which could cause the product to overturn resulting in product damage and/or personal injury.
16. Follow instructions for wall, shelf or ceiling mounting as recommended by the manufacturer.
17. An outdoor antenna should not be located in the vicinity of overhead power lines or other electrical circuits.
18. If an outside antenna is connected to the receiver be sure the antenna system is grounded so as to provide some protection against voltage surges and built up static charges. Section 810 of the National Electric Code, ANSI/NFPA No. 70-1984, provides information with respect to proper grounding for the mast and supporting structure, grounding of the lead-in wire to an antenna discharge unit, size of grounding connectors, location of antenna-discharge unit, connection to grounding electrodes and requirements for the grounding electrode.

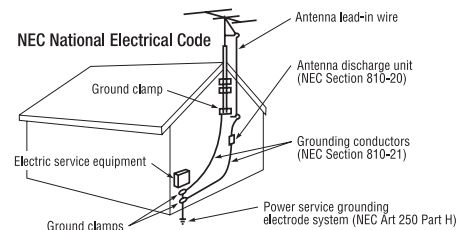

Note to the CATV system installer: This reminder is provided to call the CATV system installer's attention to Article 820-44 of the NEC that provides guidelines for proper grounding and, in particular, specifies that the cable ground shall be connected to the grounding system of the building, as close to the point of cable entry as practical.

Important Safety Instructions



Power source

This television is designed to operate on 120 volts 60 Hz, AC current. Insert the power cord into a 120 volt 60 Hz outlet. The power cord is used as the disconnect device and shall remain readily operable.

To prevent electric shock, do not use the television's (polarized) plug with an extension cord, receptacle, or other outlet unless the blades and ground terminal can be fully inserted to prevent blade exposure.

Never connect the television to 50 Hz, direct current, or anything other than the specified voltage.

Caution



Never remove the back cover of the television as this can expose you to very high voltages and other hazards. If the television does not operate properly, unplug the television and call your authorized dealer or service center.

Caution

Adjust only those controls that are covered in the instructions, as improper changes or modifications not expressly approved by **HITACHI** could void the user's warranty.

Warning

- To reduce the risk of fire or electric shock, do not expose this apparatus to rain or moisture.
- The television should not be exposed to dripping or splashing and objects filled with liquids, such as vases, should not be placed on the television.

Warning

- Do not place any objects on the top of the television which may fall or cause a child to climb to retrieve the objects.

Public viewing of copyrighted material

Public viewing of programs broadcast by TV stations and cable companies, as well as programs from other sources, may require prior authorization from the broadcaster or owner of the video program material.

This product incorporates copyright protection technology that is protected by U.S. patents and other intellectual property rights. Use of this copyright protection technology must be authorized by Macrovision Corporation, and is intended for home and other limited consumer uses only unless otherwise authorized by Macrovision. Reverse engineering or disassembly is prohibited.

Note

This digital television is capable of receiving analog basic, digital basic and digital premium cable television programming by direct connection to a cable system providing such programming. A CableCARD provided by your cable operator is required to view encrypted digital programming. Certain advanced and interactive digital cable services such as video-on-demand, a cable operator's enhanced program guide and data-enhanced television services may require the use of a set-top box. For more information call your local cable company.

Note

- There are no user serviceable parts inside the television.
- Model and serial numbers are indicated on back side of the television.

Lead/Mercury Notice

 This product contains lead and a lamp that contains mercury. Dispose of this product and its lamp in accordance with applicable environmental laws. For lamp recycling and disposal information, go to www.lamprecycle.org. For product recycling and disposal information contact your local government agency or www.eRecycle.org (in California), the Electronic Industries Alliance at www.eiae.org (in the US) or the Electronic Product Stewardship Canada at www.epsc.ca (in Canada).

FOR MORE INFORMATION, CALL 1-800-HITACHI.

Accessories

Check to make sure you have the following accessories before disposing of the packing material.

First time use

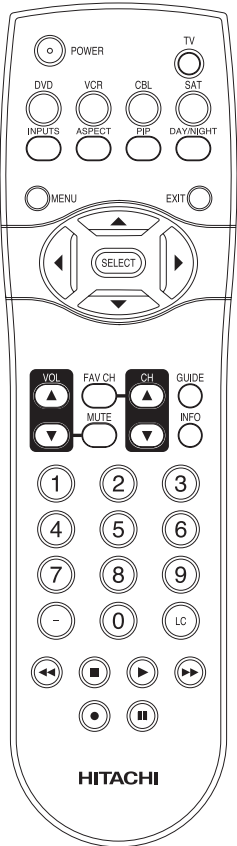
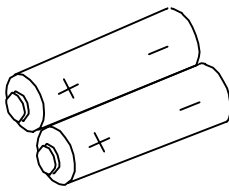
<p>1 Remote Control</p> 	<p>2 Two "AA" size, 1.5V batteries</p> 
<p><i>For US models: For optional accessories, please access our website at www.hitachi.uslvtv</i></p>	

- 1** Remote Control Unit CLU-4351UG2 (Part No. HL02072).
- 2** Two "AA" size, 1.5V batteries (For Remote Control Unit).

REMOTE CONTROL BATTERY INSTALLATION AND REPLACEMENT

1. Open the battery cover of the remote control by Lift up on tab to remove back cover.
2. Insert two new "AA" size batteries for the remote control. When replacing old batteries, push them towards the springs and lift them out.
3. Match the batteries to the (+) and (-) marks in the battery compartment.
4. Insert the bottom of the battery, the (-) side, into the battery compartment first, push towards the springs and insert the top of the battery, the (+) side, into place. Do not force the battery into the battery compartment.
5. Replace the cover.

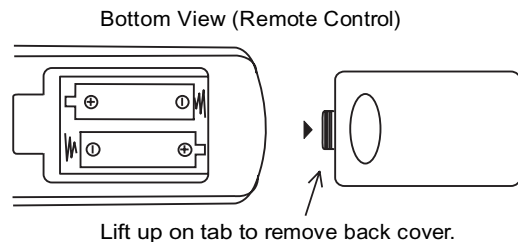

CAUTION: Do not insert batteries with the '+' and '-' polarities reversed as this may cause the batteries to swell or rupture resulting in leakage.

How to set up your new HITACHI Projection Television

ANTENNA

Unless your LCD Rear PTV is connected to a cable TV system or to a centralized antenna system, a good outdoor TV antenna is recommended for best performance. However, if you are located in an exceptionally good signal area that is free from interference and multiple image ghosts, an indoor antenna may be sufficient.

LOCATION

Select an area where sunlight or bright indoor illumination will not fall directly on the picture screen. Also, be sure that the location selected allows a free flow of air to and from the perforated back cover of the set. To avoid cabinet warping, cabinet color changes, and increased chance of set failure, do not place the TV where temperatures can become excessively hot, for example, in direct sunlight or near a heating appliance, etc. When using your LCD Rear PTV against a wall, keep it at least 10cm (4 inches) from the wall.

NOTE: Your new HDTV has a built-in high definition television signal processor. This television includes a fan to cool the processor. The sound of moving air from the fan is normal and may be noticeable in very quiet environments.

VIEWING

The major benefit of the **HITACHI** LCD Rear PTV is its large viewing screen. To see this large screen at its best, test various locations in the room to find the optimum spot for viewing.

The best picture is seen by sitting directly in front of the TV and about 10 to 18 feet from the screen. Picture brightness decreases as the viewer moves to the left and right of the receiver.

During daylight hours, reflections from outside light may appear on the screen. If so, drapes or screens can be used to reduce the reflection or the TV can be located in a different section of the room.

If the TV's audio output will be connected to a Hi-Fi system's external speakers, the best audio performance will be obtained by placing the speakers equidistant from each side of the receiver cabinet and as close as possible to the height of the picture screen center. For best stereo separation, place the external speakers at least four feet from the side of the TV, place the surround speakers to the side or behind the viewing area. Differences in room sizes and acoustical environments will require some experimentation with speaker placement for best performance.

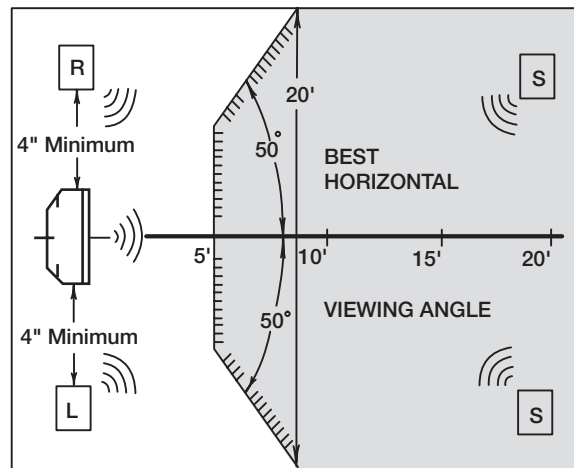
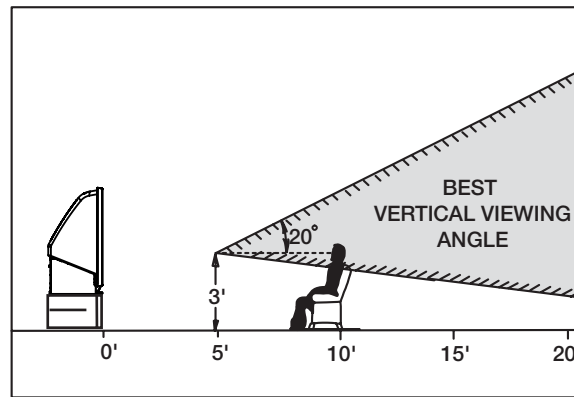

IMPORTANT NOTES:

1. Since LCD Rear PTV incorporates a high pressure lamp to display an image, it may take about one minute for the picture to become stable, after the power has been turned on. After extended use, the picture may darken, the color may look unusual, or the lamp "goes out," (burns out). You may hear a "pop" sound when the lamp "goes out." These are common characteristics of the lamp, and should not be considered defective.
2. LCD Rear PTV incorporates an advanced cooling fan system to prevent from overheating. If you hear the cooling fan, it should not be considered defective.
3. If you hear a "cracking" sound from the TV cabinet, it is due to the TV's cabinet expanding and contracting due to room temperature changes. It has no effect on the TV's functions.
4. The LCD Rear PTV cabinet is constructed with wood and plastic. Make sure to place it on a flat surface. An uneven surface might warp the cabinet and reduce the picture quality.

Hook-up Cables and Connectors

First time use

Most video/audio connections between components can be made with shielded video and audio cables that have phono connectors. For best performance, video cables should use 75-Ohm coaxial shielded wire. Cables can be purchased from most stores that sell audio/video products. Below are illustrations and names of common connectors. Before purchasing any cables, be sure of the output and input connector types required by the various components and the length of each cable.

300-Ohm Twin Lead Cable

This outdoor antenna cable must be connected to an antenna adapter (300-Ohm to 75-Ohm).

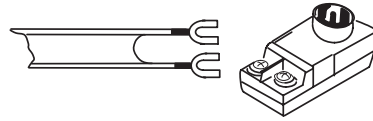

Phono Cable

Used on all standard video and audio cables which connect to inputs and outputs located on the television's rear jack panel and front control panel.



"F" Type 75-Ohm Coaxial Antenna Cable

For connecting RF signals (antenna or cable TV) to the antenna jack on the television.



S-Video (Super Video) Cable

This connector is used on camcorders, VCRs and laser-disc players with an S-Video feature in place of the standard video cable to produce a high quality picture.

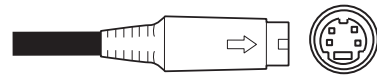

Optical Cable

This cable is used to connect to an audio amplifier with an Optical Audio In jack. Use this cable for the best sound quality.

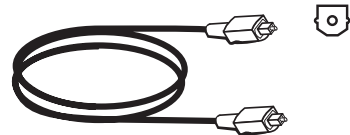

HDMI Cable

This cable is used to connect your external devices such as Set-Top-Boxes or DVD players equipped with an HDMI output connection to the TV's HDMI input.

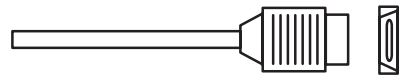

ANTENNA CONNECTIONS TO REAR JACK PANEL

VHF (75-Ohm) antenna/CATV (Cable TV)

When using a 75-Ohm coaxial cable system, connect **CATV** coaxial cable to the **AIR/CABLE** (75-Ohm) terminal. Or if you have an antenna, connect the coaxial cable to the same **AIR/CABLE** terminal.

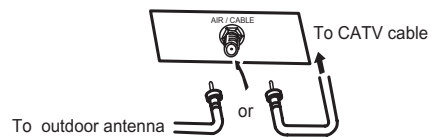

VHF (300-Ohm) antenna/UHF antenna

When using a 300-Ohm twin lead from an outdoor antenna, connect the **VHF** or **UHF** antenna leads to screws of the **VHF** or **UHF** adapter. Plug the adapter into the antenna terminal on the TV.

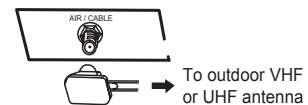

When both VHF and UHF antennas are connected

Attach an optional antenna cable mixer to the TV antenna terminal, and connect the cables to the antenna mixer. Consult your dealer or service store for the antenna mixer.

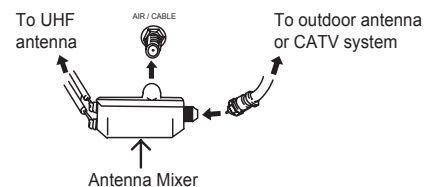

NOTE: Connecting a 300-Ohm twin lead connector may cause interference. Using a 75-Ohm coaxial cable is recommended.

Quick Reference Remote Control Buttons and Functions

In addition to controlling all of the functions on your HITACHI LCD Rear Projection TV, the new remote control is designed to operate different types of devices, such as, DVD Players, CBL (Cable Boxes), set-top-boxes, satellite receivers, and VCRs. The remote control must be programmed to control the chosen device. Please see pages 19-30 for a complete description of all features and programming of the Remote Control.

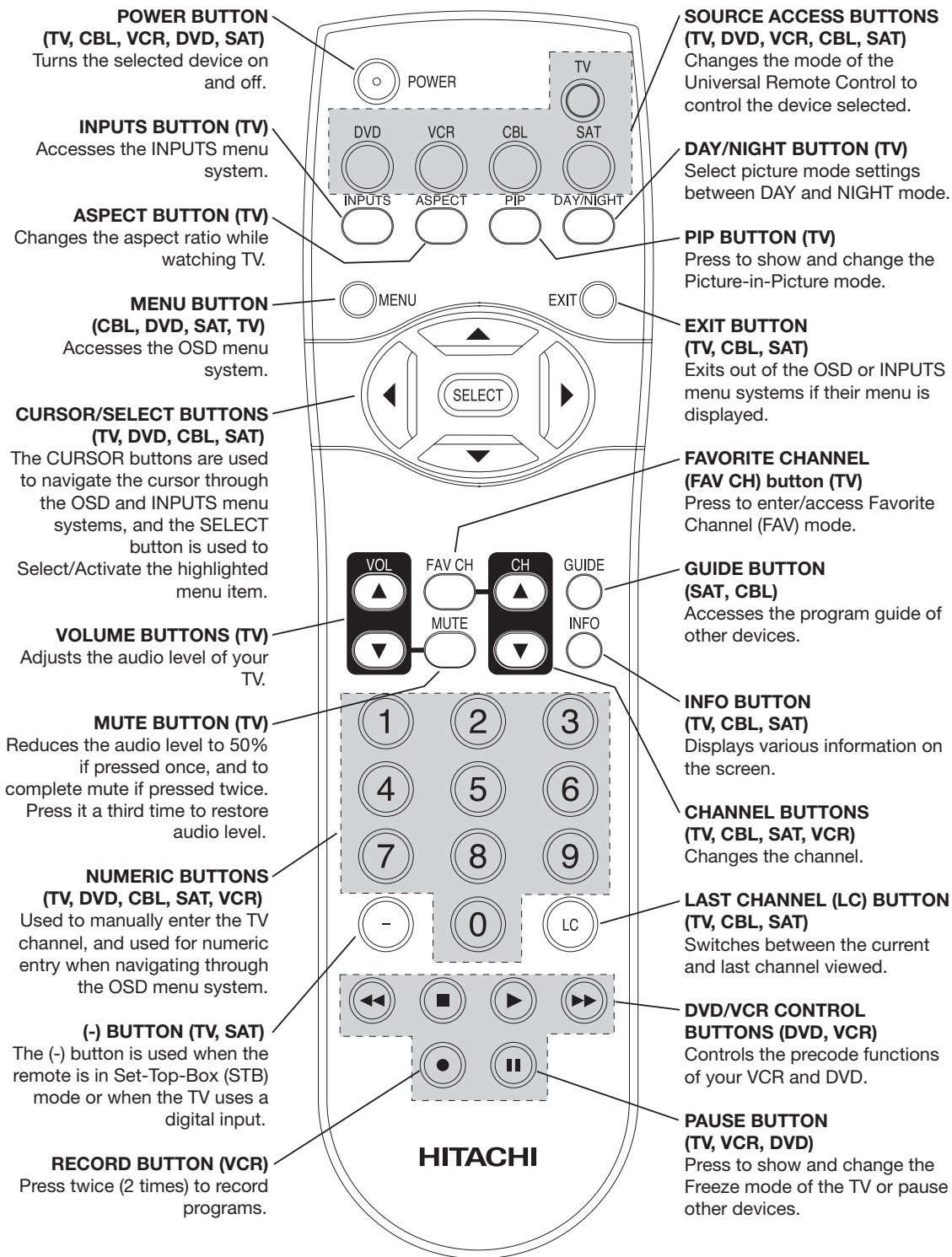

LEGEND

TV – Television
CBL – Cable Box
SAT – Satellite Receiver
VCR – Video Cassette Recorder/Player
DVD – Digital Video Disc Player

NOTE: STB precode is included in the SAT mode.

Front Panel Controls

First time use

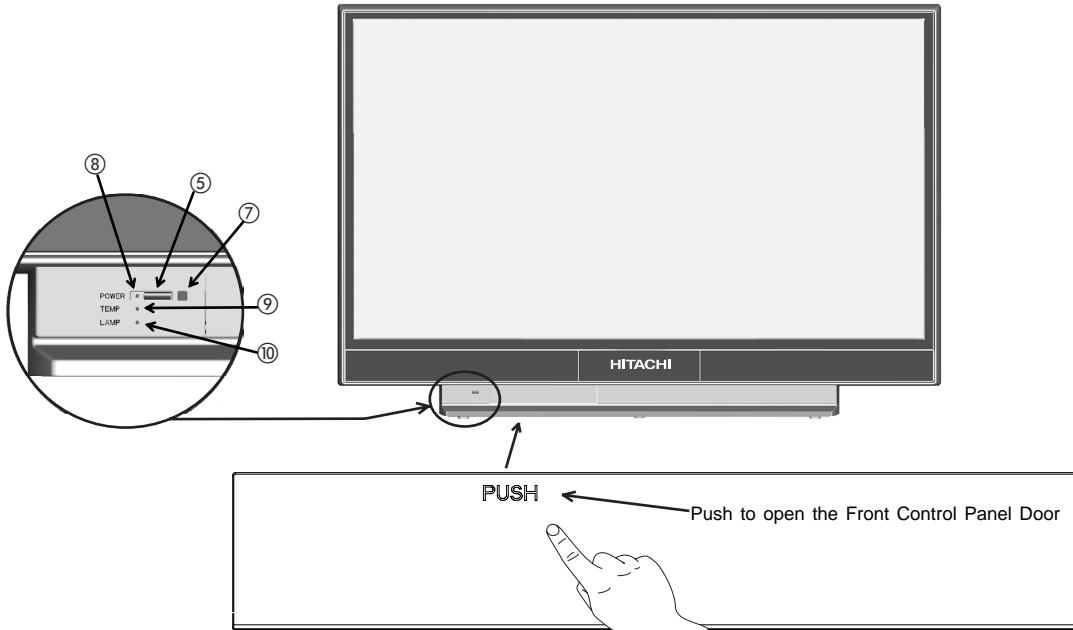

Front Control Panel Buttons & Connections

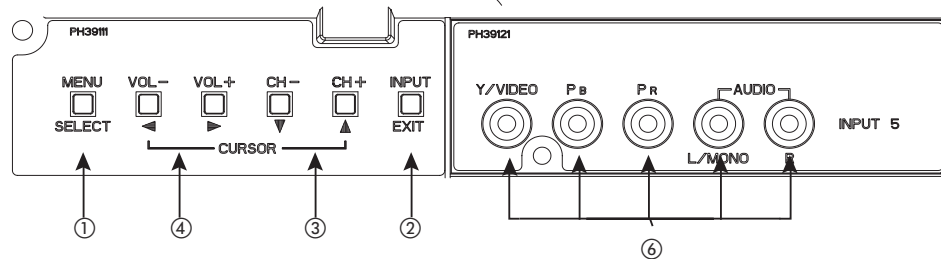

1 MENU/SELECT button

This button allows you to enter the **MENU**, making it possible to set TV features to your preference without using the remote. This button also serves as the **SELECT** button when in **MENU** mode.

2 INPUT/EXIT button

Press this button to display the input menu selections of **CABLE/ AIR**, **INPUT: 1, 2, 3, 4** and **5**. This button also serves as the **EXIT** button when in **MENU** mode.

3 CHANNEL selector

Press these buttons until the desired channel appears in the top right corner of the TV screen. These buttons also serve as the cursor down (▼) and up (▲) buttons when in **MENU** mode.

4 VOLUME level

Press these buttons for your desired sound level. The volume level will be displayed on the TV screen. These buttons also serve as the cursor left (◀) and right (▶) buttons when in **MENU** mode. When the TV power is turned OFF at a volume level 31 or greater, the volume level will default to 30 when the TV is turned ON. However, if it is set to a level 30 or less, the volume level will be at the level it was set when the TV is turned ON.

5 POWER button

Press this button to turn the TV ON or OFF.

6 FRONT INPUT JACKS (INPUT 5)

Use these audio/video jacks for a quick hook-up from a camcorder, VCR or a Y-PbPr capability device to instantly view your favorite show, new recording or Video game. Press the **INPUT** button and select **INPUT 5**. If you have mono sound insert the audio cable into the left audio jack.

7 IR RECEIVER Sensor

Point the remote control at this area when selecting channels, adjusting volume, etc.

Front Panel Controls

8 POWER Light

When the TV is turned ON, the Power Light will first blink to indicate that the television lamp is warming up. This light will be ON during normal operation. When the TV is turned OFF, the Power Light will blink to indicate that the television lamp will be cooling down and the light will eventually turn off.

9 TEMP Indicator

This light is off during normal operation. If this indicator is lit, the optic unit is too hot. If this indicator is blinking, the cooling fan has stopped. Please call service. The optic unit has an air filter that may become clogged over time. The internal temperature will increase which will trigger the temperature sensor to display an On-Screen warning. After 5 minutes, the lamp will turn off, then the TV will turn off with the TEMP LED On.

10 LAMP Indicator

This light is off during normal operation. If light is lit, the lamp has failed. See page 56-59 for lamp replacement procedure. Consult your Hitachi dealer for proper part. If light is blinking, lamp cover is not assembled securely after replacement.

NOTES:

INDICATOR	INDICATION	MEANING	ACTION
LAMP LED	LIGHT ON	NO LAMP LIGHT or BROKEN LAMP	Need to replace if LAMP still does not light by Power On " again. Check assembly condition of LAMP UNIT
	BLINKING	WRONG LAMP UNIT ASSEMBLY / LAMP DOOR OPEN	
TEMP LED	LIGHT ON	Too hot inside the OPTICAL unit	Call for Service
	BLINKING	COOLING FAN STOPPED	
POWER LED	INTERMEDIATE BLINKING (0.5 SEC CYCLE)	BEGINNING OF WARM UP AFTER THE POWER ON.	
	LIGHT ON	NORMAL OPERATION	
	SHORT BLINKING (0.3 SEC CYCLE)	BEGINNING OF COOL DOWN (FOR 20 SEC.) (TV CANNOT ACCEPT ANY CODE IN THIS PERIOD EXCEPT WITHIN THE FIRST 5 SEC. OF COOLDOWN)	
	LONG BLINKING (1 SEC CYCLE)	COOL DOWN (FOR 6 MINUTES) (TV CAN ACCEPT REMOTE CONTROL AND FRONT BUTTONS)	

2. If the LAMP, TEMP, and POWER LED are blinking in the order below, the television is warming up.

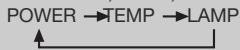

3. Your Hitachi LCD Rear Projection Television may appear to be OFF when it is set to input 1 ~ input 5 and the video signal is not received from the input jacks. Please make sure the Blue Power light indicator is not lit (OFF) when you are not watching for long lasting performance.

4. Your Hitachi LCD Rear Projection Television has an internal lamp that lights up the TV screen. Make sure to turn off the Power when you do not watch the LCD Rear Projection Television for longer lamp life

Front Panel Jacks and Connections

The Front panel jacks are provided as a convenience to allow you to easily connect a camcorder , DVD, Video Game as shown in the following examples :

Front Control Panel Connections

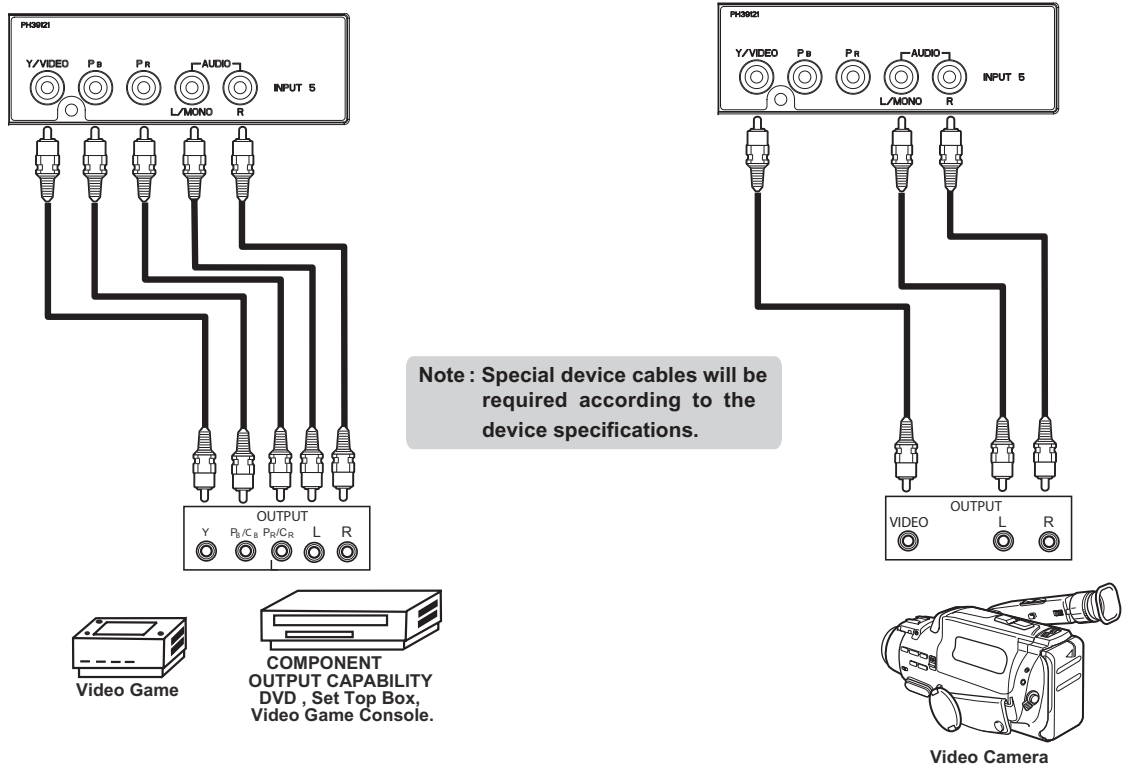

NOTE: 1. Completely insert connection cord plugs when connecting to front panel jacks. If you do not, the played back picture may be abnormal.

The exact arrangement you use to connect the VCR, camcorder, laserdisc player, DVD player, or HDTV Set Top Box to your LCD TV is dependent on the model and features of each component. Check the owner's manual of each component for the location of video and audio inputs and outputs.

The following connection diagrams are offered as suggestions. However, you may need to modify them to accommodate your particular assortment of components and features. For best performance, video and audio cables should be made from coaxial shielded wire.

Before Operating External Video Source

Connect an external source to one of the INPUT terminals, then press the INPUTS button to show the INPUTS menu. Use the CURSOR PAD (▲ and ▼) to select the Input of your choice. Then press the SELECT button or the CURSOR PAD ► to confirm your choice (see page 22).

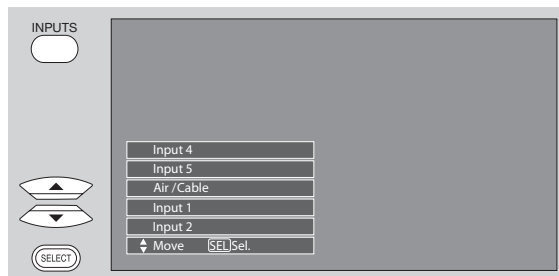

Rear Panel Connections

① Antenna Input

To switch between Cable and Air input, go to the Channel Manager option to change the signal source CABLE or AIR.

② Audio/Video INPUTS 1, 2, 3 and 4

By using the INPUTS button, the CURSOR PAD (▲ and ▼), and the SELECT button or CURSOR PAD ► of the remote control, you can select each video source. Use the audio and video inputs to connect external devices, such as VCRs, camcorders, laserdisc players, DVD players etc. (if you have mono sound, insert the audio cable into the left audio jack).

③ MONITOR OUT & HI-FI AUDIO OUT

These jacks provide fixed and variable audio and video signals (CABLE/AIR or INPUTS) which are used for recording. Use the S-VIDEO Output for high quality video output. Component signal to INPUT 3, 4 and 5, and HDMI inputs will not have monitor output.

④ Optical Out (Digital Audio)

This jack provides Digital Audio Output for your audio device that is Dolby® Digital and PCM compatible, such as an audio amplifier.

NOTE: *Manufactured under license from Dolby Laboratories. "Dolby" and the double-D symbol are trademarks of Dolby Laboratories.

⑤ S-VIDEO INPUTS 1 and 2

INPUTS 1 and 2 provide S-VIDEO (Super Video) jacks for connecting equipment with S-VIDEO output capability.

NOTE: 1. You may use HDMI, VIDEO or S-VIDEO inputs to connect to INPUT 1 and 2, but only one of these inputs may be used at a time.
2. S-VIDEO output may be used for recording, only when the input is of S-VIDEO type.

⑥ HDMI INPUTS 1 and 2 (High Definition Multimedia Interface)

ABOUT HDMI – HDMI is the next-generation all digital interface for consumer electronics. **HDMI** enables the secure distribution of high-definition video and multi-channel audio in a single cable. Because digital television (DTV) signals remain in digital format, **HDMI** assures that pristine high-definition images retain the highest video quality from the source all the way to your television screen.

Use the **HDMI** input for your external devices such as Set-Top-Boxes or DVD players equipped with an **HDMI** output connection.

HDMI, the **HDMI** logo and High-Definition Multimedia Interface are trademarks or registered trademarks of **HDMI** Licensing LLC.

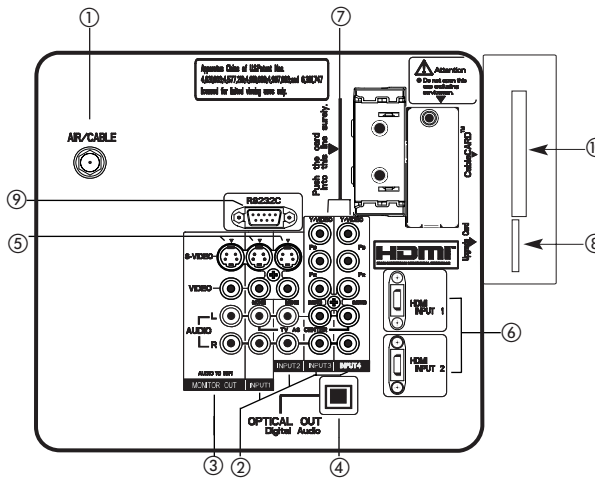

NOTE: 1. The HDMI input is not intended for use with personal computers.
2. Only DTV formats such as 1080i, 720p, 480i and 480p are available for HDMI input.

⑦ Component: Y-PbPr Inputs

INPUTS 3 and 4 provide Y-PbPr jacks for connecting equipment with this capability, such as a DVD player or Set Top Box. You may use composite video signal for both inputs.

NOTE: 1. Do not connect composite VIDEO and S-VIDEO to INPUT 1, 2 at the same time. S-VIDEO has priority over VIDEO input.
2. Your component outputs may be labeled Y, B-Y, and R-Y. In this case, connect the components B-Y output to the TV's Pb input and the components R-Y output to the TV's Pr input.
3. Your component outputs may be labeled Y-CbCr. In this case, connect the component Cb output to the TV's Pb input and the component Cr output to the TV's Pr input.
4. It may be necessary to adjust TINT to obtain optimum picture quality when using the Y-PbPr inputs (see page 33).
5. To ensure no copyright infringement, the MONITOR OUT output will be abnormal, when using the Y-PbPr jacks.
6. INPUT 3, 4 and INPUT 5 (Y/VIDEO) can be used for composite video and component video input.

⑧ Upgrade Card

This card slot is for future software upgrades. HITACHI will notify you if a software upgrade is required for your TV. In order to receive written notification, please complete and return your warranty card.

⑨ For AV control use Only

Rear Panel Connections

⑩ CableCARD Slot

This slot is for the CableCARD that will be provided by your local cable operator to gain access to chosen cable channels. Please call your local cable operator if this service is available before requesting a CableCARD (also known as Point of Deployment (POD) module).

1. Connect a coaxial cable to cable terminal of the Rear Panel Jacks.
2. Insert the CableCARD into the slot (Top of card should be facing towards you as shown below).

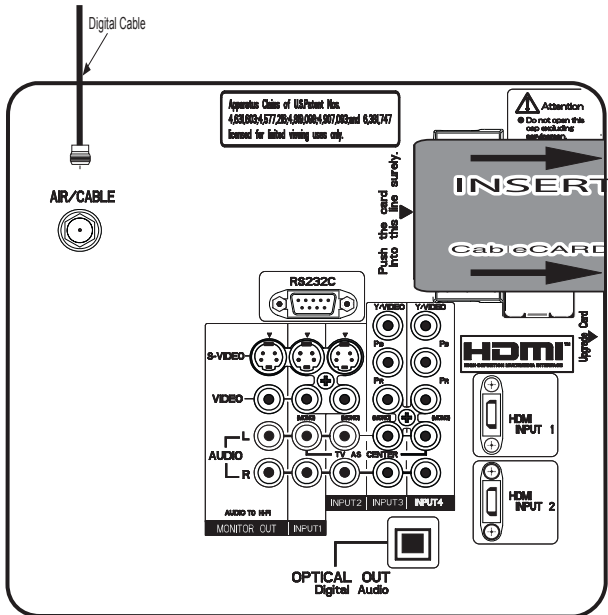

NOTE: 1. A digital cable subscription is required.
2. Do not insert a PCMCIA card into the CableCARD slot.

If the CableCARD is properly installed or removed, the TV will display the following respective screens.

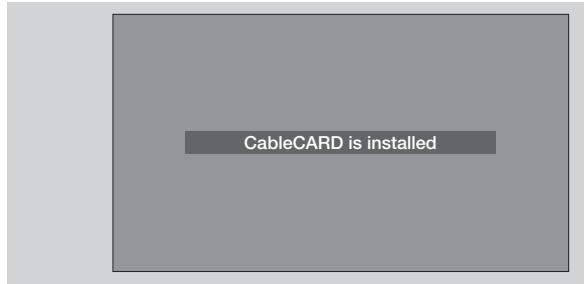

OR



After the CableCARD is installed, wait until the second screen below appears. The third screen below will appear if a channel is not authorized for viewing. Press the **EXIT** button to exit the second screen.

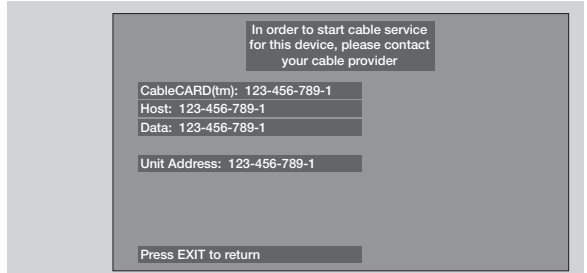

OR



Please take note of all information on the screen (you will provide this information to your cable operator). Call your cable operator and give them the information from the card to start your cable service.

NOTE: Please make reference to CableCARD information from SETUP menu (see page 54).

Rear Panel Connections

First time use

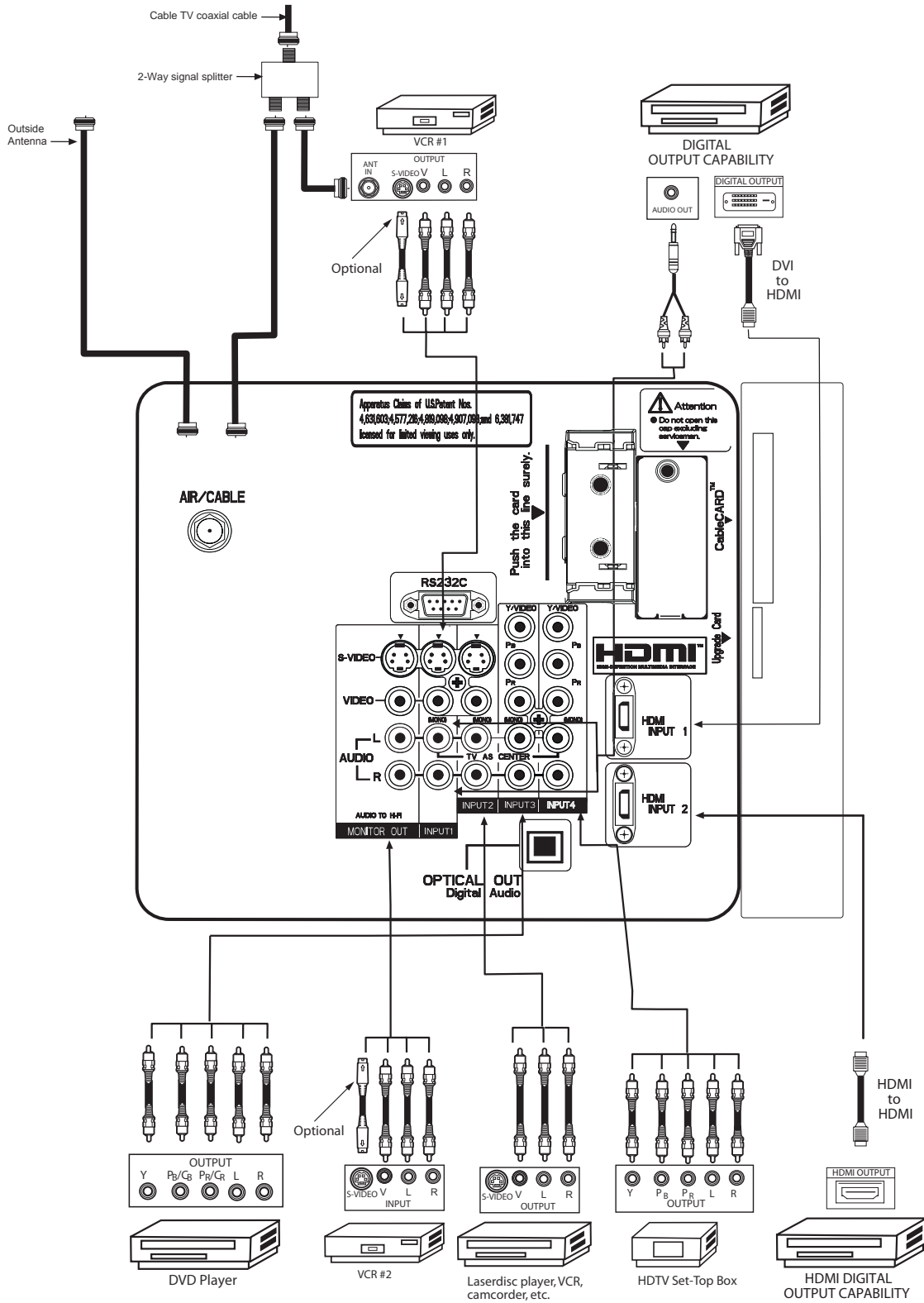

NOTE: Cables are optional, except when specified.

Tips on Rear Panel Connections

- S-VIDEO, Y-P_BP_R, or HDMI connections are provided for high performance laserdisc players, VCRs etc. that have this feature. Use these connections in place of the standard video connection if your device has this feature.
- If your device has only one audio output (mono sound), connect it to the left audio jack on (L/(MONO)) the Rear Panel.
- Refer to the operating guide of your other electronic equipment for additional information on connecting your hook-up cables.
- A single VCR can be used for VCR #1 and VCR #2, but note that a VCR cannot record its own video or line output (INPUT: 1 in the example on page 14). Refer to your VCR operating guide for more information on line input-output connections.
- Connect only 1 component (VCR, DVD player, camcorder, etc.) to each input jack.
- COMPONENT: Y-P_BP_R (Input 3, 4 & 5) connections are provided for high performance components, such as DVD players and set-top-boxes. Use these connections in place of the standard video connection if your device has this feature.
- Your component outputs may be labeled Y, B-Y, and R-Y. In this case, connect the components B-Y output to the TV's P_B input and the components R-Y output to the TV's P_R input.
- Your component outputs may be labeled Y-C_BC_R. In this case, connect the components C_B output to the TV's P_B input and the components C_R output to the TV's P_R input.
- It may be necessary to adjust TINT to obtain optimum picture quality when using the Y-P_BP_R inputs. (See page 33)
- To ensure no copyright infringement, the MONITOR OUT output will be abnormal, when using the Y-P_BP_R and HDMI input jacks.
- Input 1 or 2 can accept HDMI signal.
- S-VIDEO monitor output may be used for recording only when the input is of S-VIDEO type.
- When using a HDMI input from a Set-Top-Box, it is recommended to use a 1080i or 720p input signal.

INSTALLATION RECOMMENDATION:

1. Video signals fed through a VCR may be affected by copyright protection systems and the picture will be distorted on the television.
2. Connecting the television directly to the Audio /Video output of a Set-Top-Box will assure a more normal picture.

Connecting External Video Sources

CONNECTING A VIDEO AND STEREO AUDIO SOURCE TO INPUT 1 - INPUT 5

1. Connect the cable from the VIDEO OUT of the VCR or the laserdisc player to the INPUT (VIDEO) jack, as shown on the Rear Panel to the right.
2. Connect the cable from the AUDIO OUT R of the VCR or the laserdisc player to the INPUT (AUDIO/R) jack.
3. Connect the cable from the AUDIO OUT L of the VCR or the laserdisc player to the INPUT (AUDIO/L) jack.
4. Press the INPUTS button, then select INPUT 2 from the INPUTS menu to view the program from the VCR or laserdisc player.
5. Select CABLE or AIR from the INPUTS menu to return to the last channel tuned.

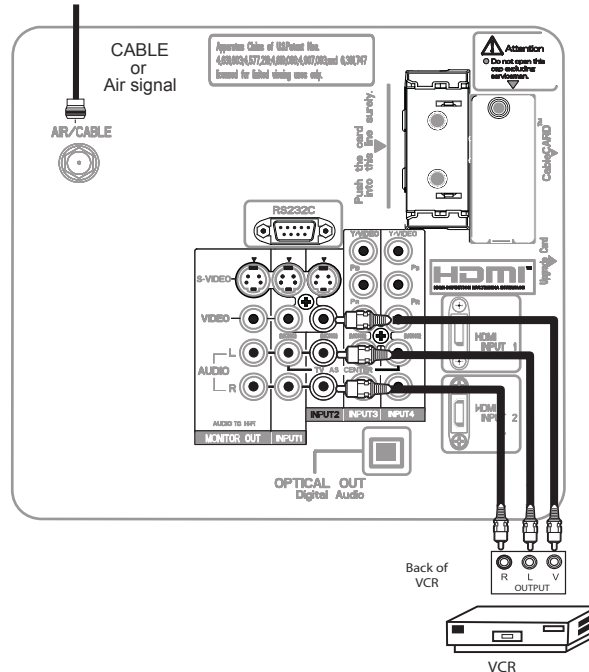

- NOTE:**
1. Completely insert the connection cord plugs when connecting to rear panel jacks. The picture and sound that is played back will be abnormal if the connection is loose.
 2. A single VCR can be used for VCR #1 and VCR #2 (see page 13) but note that a VCR cannot record its own video or line output. Refer to your VCR operating guide for more information on line input-output connections.
 3. When INPUT 3, 4 or 5 are used, it is necessary to connect the video output of the device to the Y/VIDEO input jack of the TV (For INPUT 5 please see page 10 for reference).

CONNECTING AN S-VIDEO AND STEREO AUDIO SOURCE TO INPUT 1, 2

1. Connect the cable from the S-VIDEO OUT of the S-VHS VCR or the laserdisc player to the INPUT (S-VIDEO) jack, as shown on the Rear Panel to the right.
2. Connect the cable from the AUDIO OUT R of the VCR or the laserdisc player to the INPUT (AUDIO/R) jack.
3. Connect the cable from the AUDIO OUT L of the VCR or the laserdisc player to the INPUT (AUDIO/L) jack.
4. Press the INPUTS button, then select INPUT 1 from the INPUTS menu to view the program from the VCR or laserdisc player.
5. Select CABLE or AIR from the INPUTS menu to return to the last channel tuned.

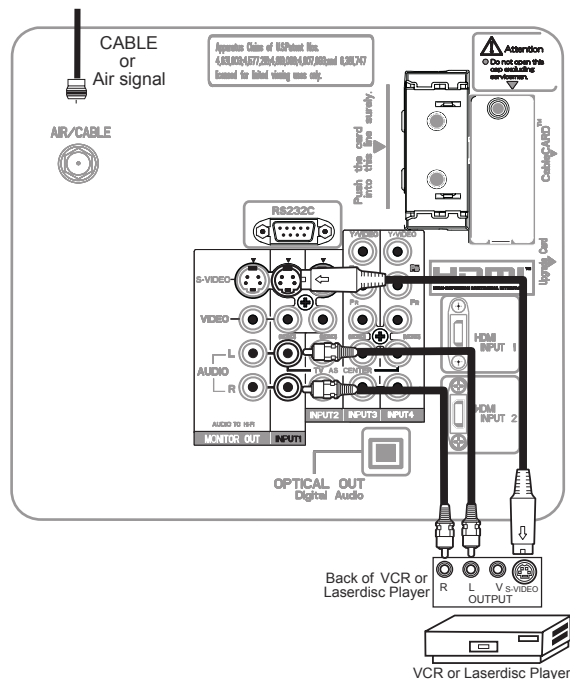

- NOTE:**
1. Completely insert the connection cord plugs when connecting to rear panel jacks. The picture and sound that is played back will be abnormal if the connection is loose.
 2. A single VCR can be used for VCR #1 and VCR #2 (see page 13), but note that a VCR cannot record its own video or line output. Refer to your VCR operating guide for more information on line input-output connections.

Connecting External Video Sources

CONNECTING A COMPONENT SOURCE WITH HDMI OR DVI CAPABILITY TO INPUT 1 OR 2

1. Connect the HDMI or DVI to HDMI connection cable from the output of the HDTV set top box or DVD player to the HDMI input as shown on the Rear panel below.
2. With DVI output, connect the cable from the AUDIO OUT R of the HDTV set top box or DVD player to the INPUT (AUDIO/R) jack as shown on the Rear Panel below.
3. With DVI output, connect the cable from the AUDIO OUT L of the HDTV set top box or DVD player to the INPUT (AUDIO/L) jack as shown on the Rear Panel below.
4. Press the INPUTS button, then select INPUTS 1, or 2 to view the program from the HDTV set top box or DVD player.
5. Select CABLE or AIR from the INPUTS menu to return to the last channel viewed.

- NOTE:**
1. Completely insert the connection cord plugs when connecting to rear panel jacks. The picture and sound that is played back will be abnormal if the connection is loose.
 2. The HDMI input on INPUT 1 and 2 contains the copy protection system called High-bandwidth Digital Content Protection (HDCP). HDCP is a cryptographic system that encrypts video signals when using HDMI connections to prevent illegal copying of video contents.
 3. HDMI is not a "NETWORK" technology. It establishes a one-way point-to-point connection for delivery of uncompressed video to a display.
 4. The connected digital output device controls the HDMI interface so proper set-up of device user settings determines final video appearance.
 5. When using a DVI to HDMI cable, connect the Audio Out L and R cables at the same INPUT (1 or 2) as your HDMI INPUT(1 or 2).

HDMI input

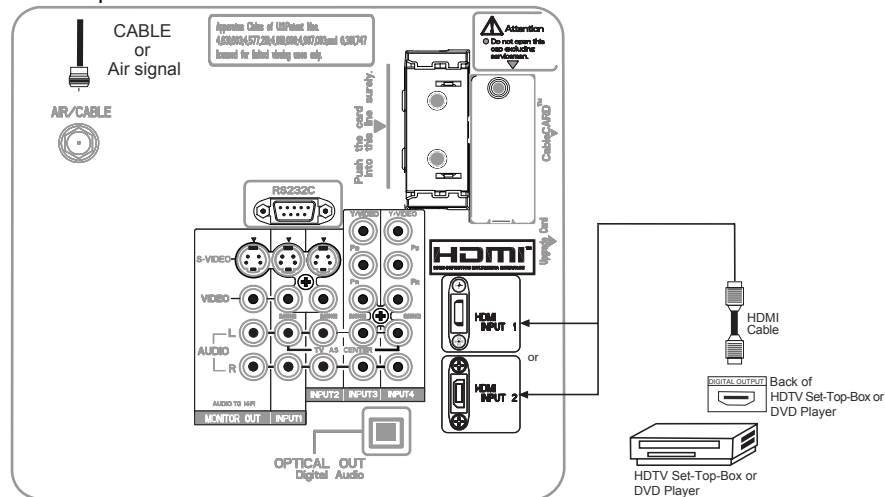

DVI to HDMI Input

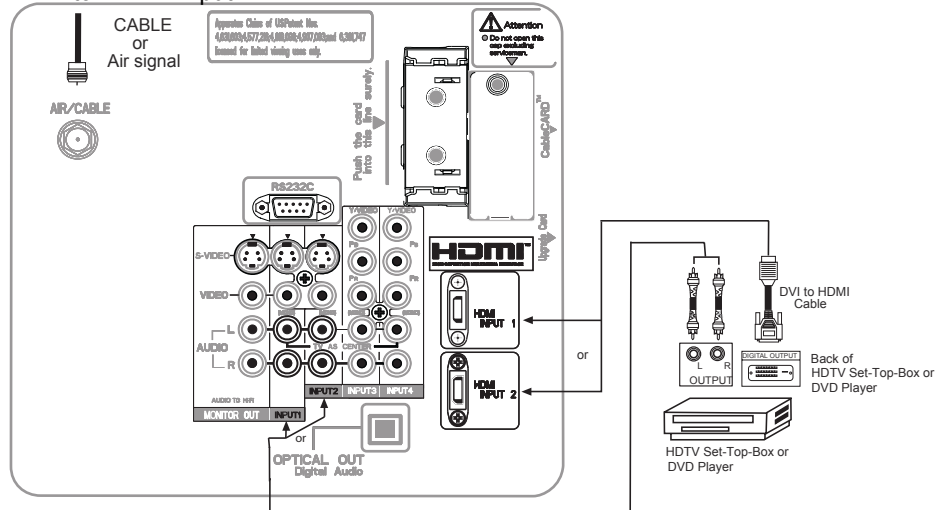

Connecting External Audio/Video Devices

CONNECTING A COMPONENT AND STEREO AUDIO SOURCE TO INPUT 3, 4 or 5 :Y-PbPr.

1. Connect the cable from the Y OUT of the Laserdisc/DVD player or HDTV set top box to the INPUT (Y) jack, as shown on the Rear panel below.
2. Connect the cable from the P_B/C_B OUT or B-Y OUT of the Laserdisc/DVD player or HDTV set top box to the INPUT (P_B) jack.
3. Connect the cable from the P_R/C_R OUT or R-Y OUT of the Laserdisc/DVD player or HDTV set top box to the INPUT (P_R) jack.
4. Connect the cable from the AUDIO OUT R of the Laserdisc/DVD player or HDTV set top box to the INPUT (AUDIO/R) jack.
5. Connect the cable from the AUDIO OUT L of the Laserdisc/DVD player or HDTV set top box to the INPUT (AUDIO/L) jack.
6. Press the INPUTS button, then select INPUT 4 from the INPUTS menu to view the program from the Laserdisc/DVD player or HDTV set top box.
7. Select CABLE or AIR to return to the last channel tuned.

NOTE: 1. Completely insert the connection cord plugs when connecting to rear panel jacks. The picture and sound that is played back will be abnormal if the connection is loose.
2. See page 14 for tips on REAR PANEL CONNECTIONS.

(For INPUT 5 please see page 10 for reference).

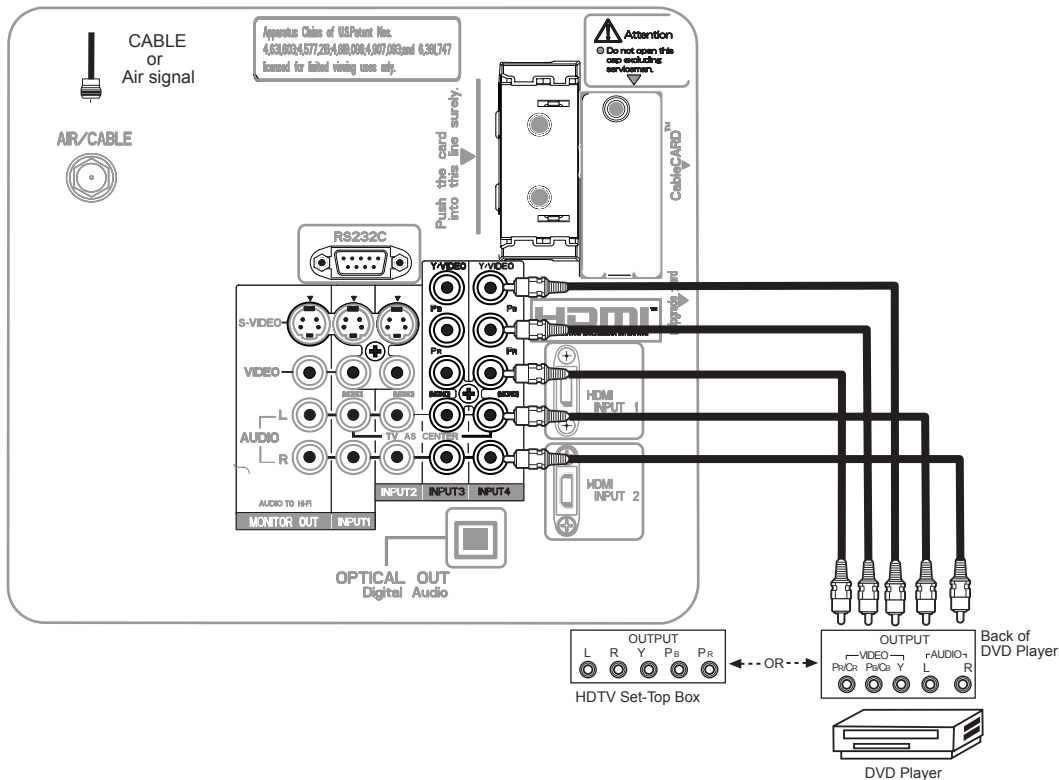

First time use

Connecting External Audio/Video Devices

CONNECTING A VIDEO AND MONAURAL AUDIO SOURCE TO INPUT 1 ~ INPUT 5

1. Connect the cable from the VIDEO OUT of the VCR or the laserdisc player to the INPUT (VIDEO) jack, as shown on the Rear Panel on the right.
2. Connect the cable from the AUDIO OUT of the VCR or the laserdisc player to the INPUT (MONO)/L(AUDIO) jack.
3. Press the INPUTS button, then select INPUT 2 from the INPUTS menu to view the program from the VCR or the laserdisc player.
4. Select CABLE or AIR from the INPUTS menu to return to the previous channel.
(For INPUT 5 please see page 10 for reference).

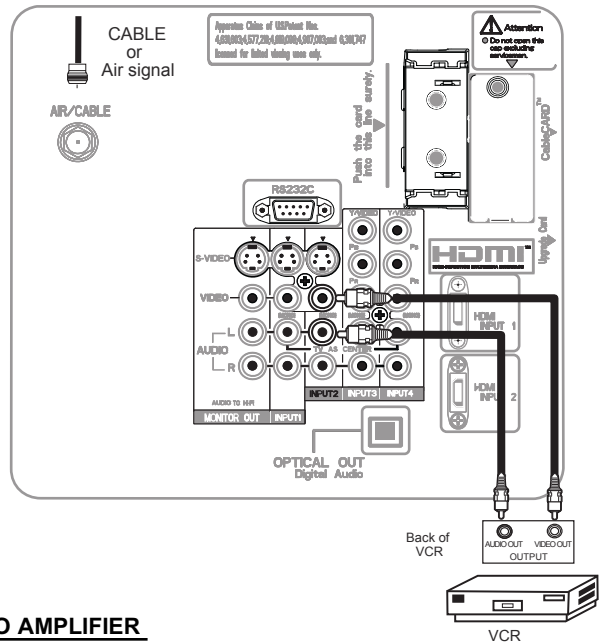

CONNECTING OPTICAL OUT TO AN EXTERNAL AUDIO AMPLIFIER

To connect the OPTICAL OUT of the TV to an external audio amplifier, connect the system as shown on the right. The "OPTICAL OUT" from the Rear Panel is a fixed output. The Volume of the amplifier is controlled by the amplifier, not by the LCD PTV. The OPTICAL OUT terminal outputs all audio sources with Optical IN capability.

1. Connect an optical cable from the Optical out to the Optical input of a separate Stereo System Amplifier as shown on the Rear Panel on the right.

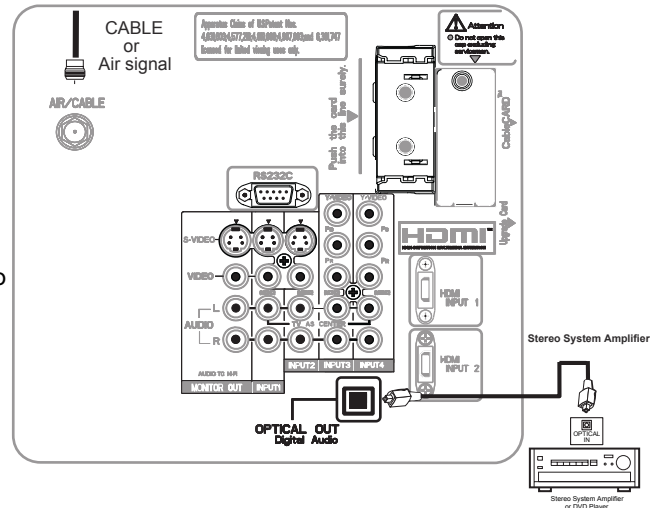

CONNECTING MONITOR OUT

The MONITOR OUT terminal outputs video and audio of CABLE/AIR and INPUTS 1, 2, 3, 4 and 5. It does not output component and HDMI video.

1. Connecting S-Video:
Connect the cable from the S-VIDEO OUT of the Rear Panel to the INPUT (S-VIDEO) jack, of the VCR .

Connecting Video:
Connect the cable from the VIDEO INPUT of the VCR to the VIDEO out jack on the TV Rear Panel.
2. Connect the cable from the AUDIO IN R of the VCR to the OUTPUT (AUDIO/R) jack on the TV Rear Panel.
3. Connect the cable from the AUDIO IN L of the VCR the OUTPUT (AUDIO/L) jack on the TV Rear Panel.

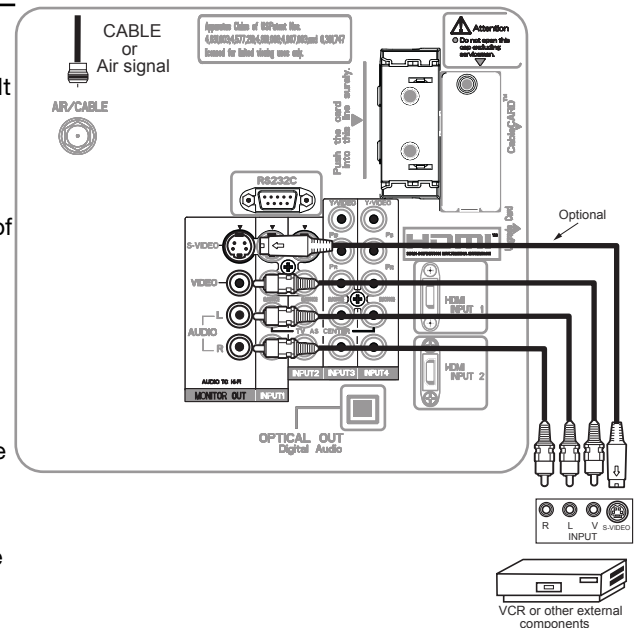

NOTE: When making video connections, connect S-Video only or Video only. If both are connected, S-Video takes priority.

The Remote Control

In addition to controlling all the functions on your **HITACHI** LCD rear projection Television, the new remote control is designed to operate different types of VCRs, CATV (Cable TV) converters, set-top-boxes, satellite receivers (SAT) and DVD players with one touch. Basic operation keys are grouped together in one area.

To operate your TV, point the remote control at the screen of the TV and press the **TV** button. The remote will now control your television.

To operate your VCR, point the remote at the remote sensor of the VCR and press the **VCR** button. The remote will now control your VCR (see page 30 for instructions on how to program the remote to control your VCR).

To operate your cable box, point the remote at the remote sensor of the cable box and press the **CABLE** (CBL) button. The remote will now control your cable box (see page 27 for instructions on how to program the remote to control your cable box).

To operate your set-top-box or satellite receiver, point the remote at the remote sensor of the set-top-box or satellite receiver and press the **SAT** button. The remote will now control your set-top-box or satellite receiver. If you have a satellite receiver, use this button to program your satellite receiver (see page 28 for instructions on how to program the remote to control your SAT).

To operate your DVD player, point the remote at the remote sensor of the DVD player and press the **DVD** button. The remote will now control your DVD player (see page 29 for instruction on how to program the remote to control your DVD player).



How to Use the Remote to Control Your TV

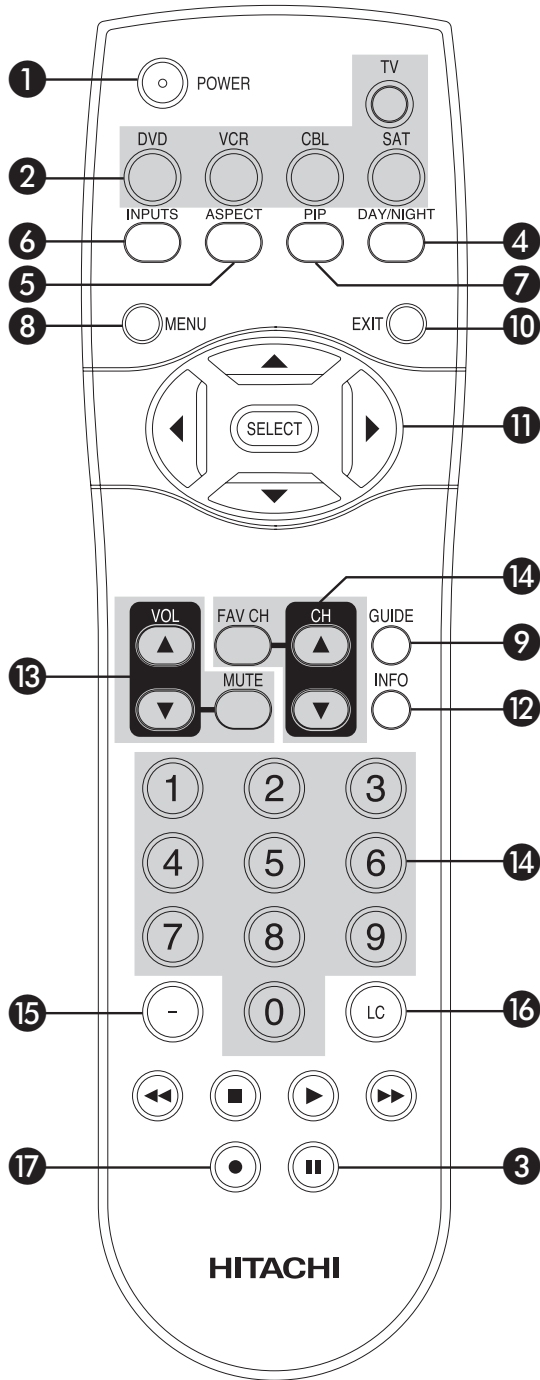

1 POWER button

Press this button to turn the TV set on or off when the remote is in TV mode.

2 MODE buttons

These buttons allow the remote to control your TV, VCR, DVD, Cable box/Satellite box depending on which button is pressed. Refer to page 31~34 for how to change between each of these modes.

3 PAUSE button

Press the **PAUSE** button to freeze the picture. Press the **EXIT** button to return the picture to motion. Press the **PAUSE** button repeatedly to cycle through the three different freeze modes (see page 26).

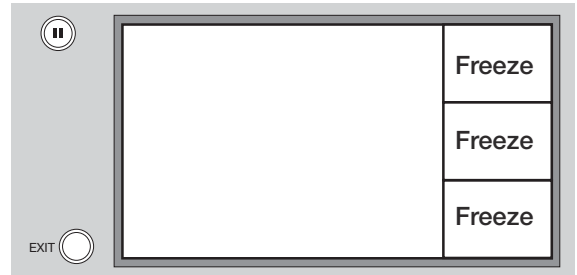
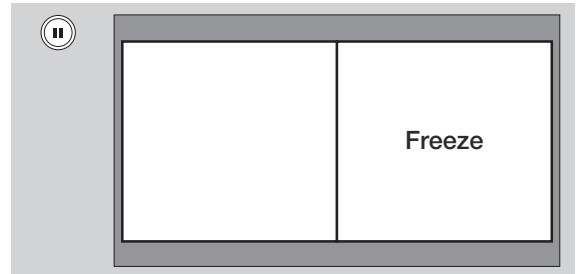
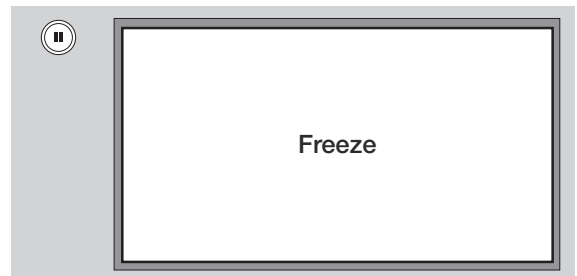

4 DAY/NIGHT button

Press this button to toggle between Day and Night picture mode settings. Select **DAY** for day time viewing with more brightness and contrast to compete with room light. Select **NIGHT** for night time viewing with less brightness and contrast for a more detailed picture (see page 33 for settings changes).

How to Use the Remote to Control Your TV

5 ASPECT button

Press this button to quickly change the picture format ASPECT ratio. Depending on the input signal format received, the picture format ratio allows you to adjust the images through the following options.

4:3 STANDARD

Use this aspect mode to display conventional (4:3) images. Side panels (gray areas) are placed to the left and right of the image to preserve the original aspect ratio of the source. Note: Use this mode for only 15% of your total viewing time to prevent uneven aging of the phosphors. Phosphors in the lighted area of the picture will age more rapidly than the gray areas.

4:3 EXPANDED

Use this aspect mode to display conventional (4:3) sources by linearly increasing image expansion from the center towards the edges of the display area in order to fill it.

4:3 ZOOM1/ZOOM2

Use these aspect modes to zoom in on conventional (4:3) sources.

16:9 STANDARD

Use this aspect mode to display 16:9 sources like HDTV and DVD's preserving the original 16:9 aspect ratio.

16:9 ZOOM

Use this aspect to Zoom-in once while in 16:9 aspect.

- Antenna-Analog Channel
- S-Video/Video Input (Auto Aspect: Off)
- HDMI-480i/480p Input (Auto Aspect: Off)
- Component-480i/480p Input (Auto Aspect: Off)

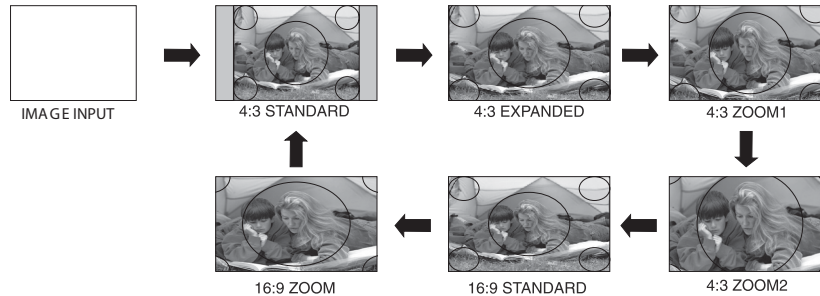

Note: Please see Appendix A on page 74.

- Antenna-Digital Channel (4:3)
- S-Video/Video 4:3/Letter Input (Auto Aspect: On)
- HDMI-480i/480p 4:3/Letter Input (Auto Aspect: On)
- Component-480i/480p 4:3/Letter Input (Auto Aspect: On)

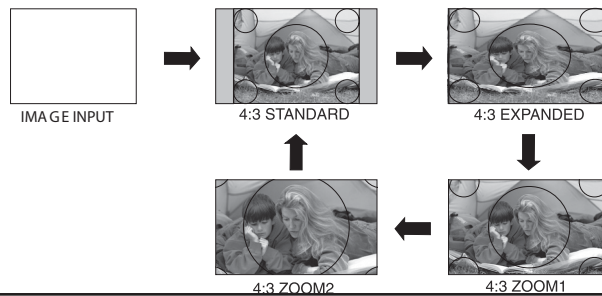

Note: Please see Appendix A on page 74.

- S-Video/Video 16:9 Input (Auto Aspect: On)
- HDMI-480i/480p 16:9 Input (Auto Aspect: On)
- Component-480i/480p 16:9 Input (Auto Aspect: On)

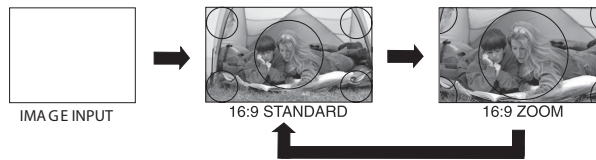

Note: Please see Appendix A on page 74.

- Antenna-Digital Channel (16:9)
- HDMI-720p/1080i Input
- Component-720p/1080i Input

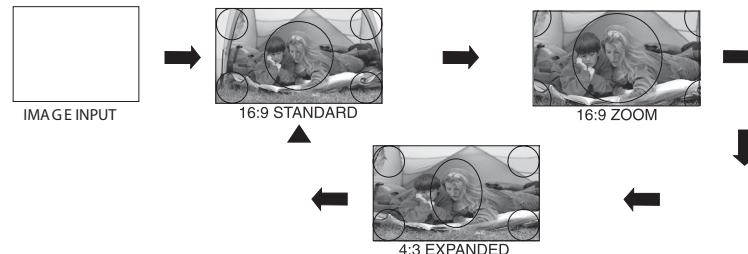

Note: Please see Appendix A on page 74.

- NOTE:** 1. The Aspect Style in all five video inputs have independent Aspect Style setting.
 2. Vertical position adjustments are directly available when you choose 4:3 EXPANDED/ZOOM1/ZOOM2 or 16:9 ZOOM aspect style (see also page 34).

How to Use the Remote to Control Your TV

6 INPUTS button

When the remote control is in TV mode, press this button to access the **INPUTS** menu. Use the **CURSOR** and **SELECT** buttons to scroll and select the inputs that are being used. Pressing the **INPUTS** button repeatedly will also cycle through the Inputs menu items. Then press the **SELECT** button to select.



- INPUT 1** Select to choose INPUT 1.

- INPUT 2** Select to choose INPUT 2.

- INPUT 3** Select to choose INPUT 3.

- INPUT 4** Select to choose INPUT 4.

- INPUT 5** Select to choose INPUT 5.

- AIR/CABLE** Select between Air or Cable signal.

7 PICTURE-IN-PICTURE button

See separate section on pages 24-25 for a description.

8 MENU button

The **MENU** button will start the On-Screen Display.

9 GUIDE button [Cable Box (CBL), Satellite Receiver (SAT) modes only]

The use of this button is only applicable when the remote control is in (CBL) and (SAT/STB) mode. Press this button to access the Channel Guide of the (CBL), and (SAT/STB).

10 EXIT button

This button will exit all On-Screen Displays.

11 CURSOR buttons/SELECT button

All the On-Screen Display features can be set or adjusted by using the **CURSOR** buttons and the **SELECT** button, except for numeric entries. Press the **CURSOR** buttons toward desired direction and press the **SELECT** button to select.

12 INFO button

Press this button when you want to check the channel being received, the picture source, if the channel has stereo (ST) or second audio program (SA), the time, CHANNEL ID and if the TIMER is set.

INFO button display for Analog Channels

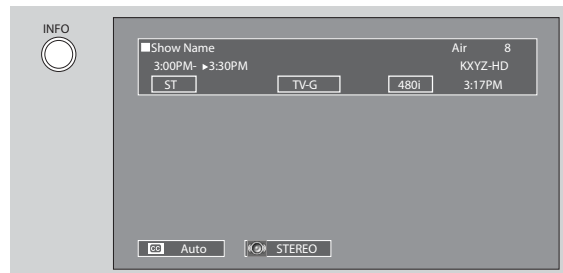

INFO button display for Digital Channels

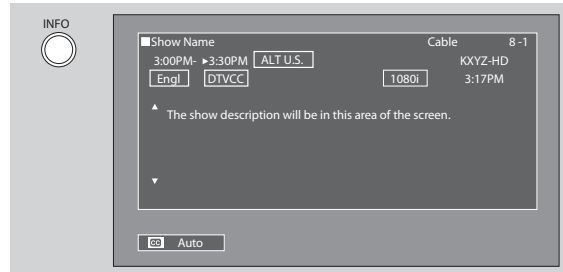
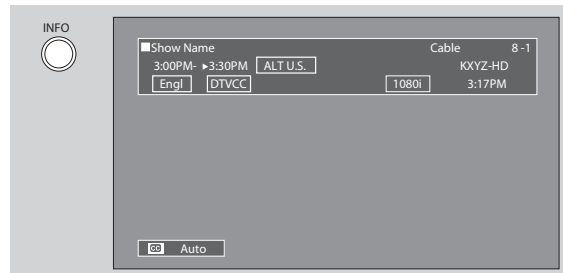

INFO button display when an S-VIDEO Input is connected to INPUT 1

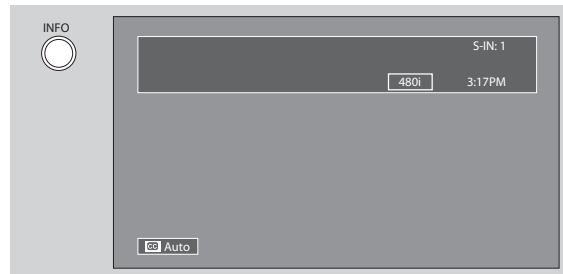

INFO button display for when a COMPONENT VIDEO: Y-PbPr Input is connected to INPUT 3



- NOTE:**
1. Press the **INFO** button again or the **EXIT** button to return to normal viewing.
 2. The Aspect setting will not be shown if the channel is locked.

How to Use the Remote to Control Your TV

13 VOLUME (VOL), MUTE button

Press the **VOLUME** button (▲ or ▼) until you obtain the desired sound level.

To reduce the sound to one half of normal volume (SOFT MUTE) to answer the telephone, etc., press the **MUTE** button. Press the **MUTE** button again to turn the sound off completely (MUTE). To restore the sound, press the **MUTE** button one more time, or **VOL UP** (▲).

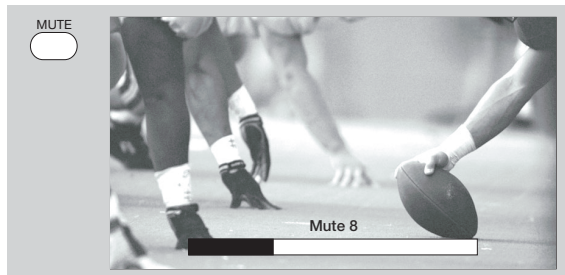
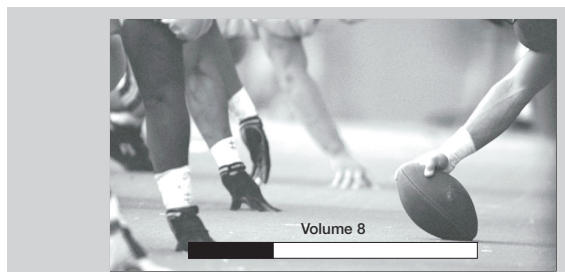

Closed Captioning will display automatically when MUTE/SOFT MUTE is on and Closed Caption is set to **AUTO** (see page 52).

When the TV power is turned off at a volume level 31 or greater, the volume level will default to 30 when the TV is turned on. However, if it is set to a level 30 or less, the volume level will be at the level it was set when the TV is turned on.

14 CHANNEL SELECTOR/FAVORITE CHANNEL (FAV CH) buttons

The **CHANNEL SELECTOR** buttons are used to select channels, lock access code, etc. Use the **CHANNEL SELECTOR** buttons to enter one, two, or three numbers to select channels. Enter **0** first for channels **1** to **9**, or simply press the single digit channel you wish to tune then wait a few seconds for the TV to tune. Channel selection may also be performed by **CHANNEL (CH) UP** (▲) or **CHANNEL (CH) DOWN** (▼).

Press the **FAV CH** button to switch to Favorite (FAV) channel mode. You will know you are in Favorite Channel mode when (FAV) is displayed and the displayed channel is **GREEN**. Press it again to return to your regular tuned channels. You can add any channel to your Favorite channel list by pressing and holding down the **FAV CH** button until the displayed channel turns from **WHITE** to highlighted **GREEN**. You can also delete a channel from your favorite channel list by pressing and holding down the **FAV CH** button until the displayed channel turns highlighted **GREEN** to **WHITE**.

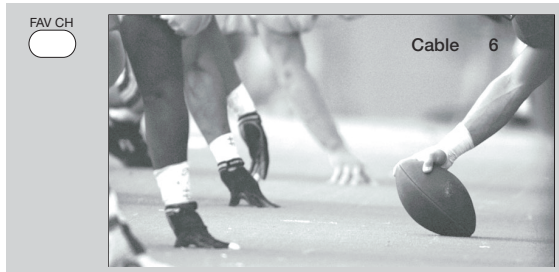
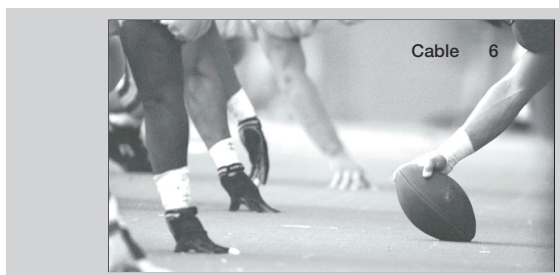

15 (-) DASH button

The **(-) DASH** button can only be used when the remote control is in Satellite (SAT) mode.

16 LAST CHANNEL (LC) button

Press this button to toggle between the current and last channel viewed.

17 RECORD button

Press twice (two times) to record programs when the remote is in VCR mode.

Picture-in-Picture (PIP)

Your **HITACHI** LCD TV incorporates one Tuner technology designed for improved viewing enjoyment. This feature allows you to view Digital Channels and Video inputs on both the main picture and sub picture simultaneously, with separate control. When a Digital channel is viewed in the main picture, the Digital or Analog channel can not be viewed in the sub picture. Please see table for PIP availability.

To select between main picture and PIP sub picture, use the **CURSOR PAD** button the remote. The Green highlighted channel display will move with every press of the **CURSOR PAD** buttons.

The Picture-in-Picture feature is convenient when you want to watch more than one program at the same time. You can watch a TV program while viewing other programs from any of the video inputs.

Use connection at right to view VCR program as a sub-picture while viewing another program as main picture (CABLE/AIR Digital channel).

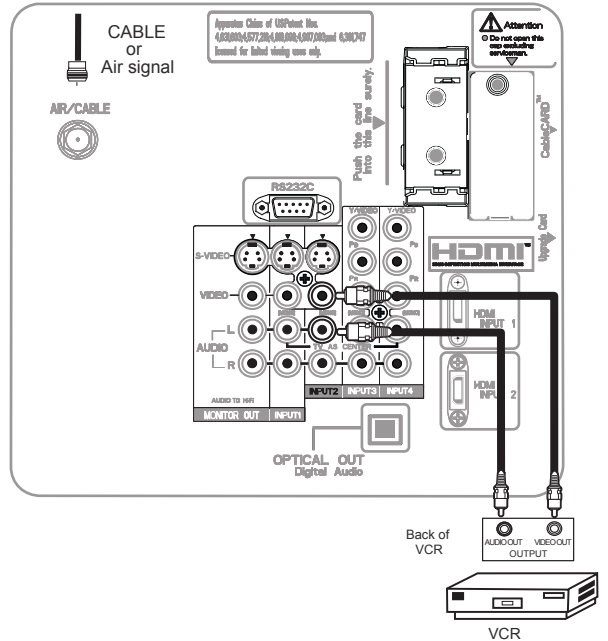

① PIP button

Press the PIP button and a sub-picture will appear in one of the four different modes (POP, PIP, or SPLIT), depending on the INPUT signal. To change the PIP mode, use the PIP button to cycle through the three different modes.

SPLIT MODE PICTURE-IN-PICTURE

Split Mode PIP displays the main picture and sub-picture evenly on the screen.



Main Picture

Sub Picture

POP MODE PICTURE-IN-PICTURE

POP Mode PIP displays the sub-picture outside of the main picture. Use the **CURSOR PAD** (▲ or ▼) to move the sub-picture. This feature is not available with a 1080i/720p signal. Please refer to the **PICTURE-IN-PICTURE MODES** Table (see page 25).

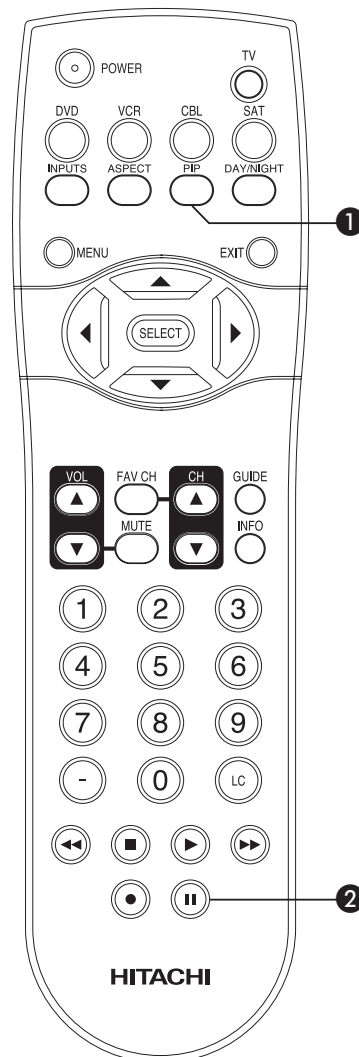
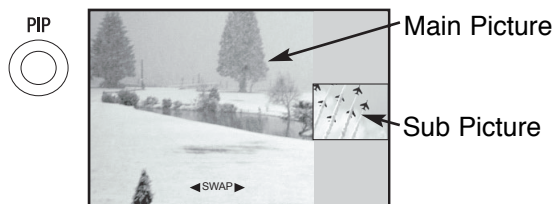

NOTE : 1. Press the **CURSOR PAD** (◀ or ▶) to enable the sub-picture sound.

Picture-In-Picture (PIP)

PIP MODE PICTURE-IN-PICTURE

Select CABLE/AIR or INPUT 1~5 from the INPUTS menu. Select a channel that has a 1080i/720p signal. To prevent a pattern burn, occasionally move the sub-picture using the CURSOR PAD.



PIP Specifications Table

PIP Mode	Scan Mode	Sub Main	Aspect	Digital Tuner		1080i	720p	480p	Video/S-Video 480i	
				16x9	4x3	16x9	16x9	16x9/4x3	16x9	4x3
POP	1080i 540p	ANT Digital	16x9	-	-	-	-	-	-	-
			4x3	-	-	YES	YES	YES	YES	YES
		1080i/720p	16x9	-	-	-	-	-	-	-
		480p/480i	16x9/4x3	YES	YES	-	-	-	-	-
		S-Video/Video	16x9/4x3	-	-	-	-	-	-	-
PIP 4x3	1080i 540p	ANT Digital	16x9	-	-	-	-	YES	YES	YES
			4x3	-	-	-	-	-	-	-
		1080i/720p	16x9	-	YES	-	-	-	-	-
		480p/480i	16x9/4x3	-	-	-	-	-	-	-
		S-Video/Video	16x9/4x3	-	-	-	-	-	-	-
PIP 16x9	1080i 540p	ANT Digital	16x9	-	-	YES	YES	YES	YES	YES
			4x3	-	-	-	-	-	-	-
		1080i/720p	16x9	YES	-	-	-	-	-	-
		480p/480i	16x9/4x3	-	-	-	-	-	-	-
		S-Video/Video	16x9/4x3	-	-	-	-	-	-	-
SPLIT	1080i 540p	ANT Digital	16x9	-	-	YES	YES	YES	YES	YES
			4x3	-	-	YES	YES	YES	YES	YES
		1080i	16x9	YES	YES	-	-	-	-	-
		720p	16x9	YES	YES	-	-	-	-	-
		480p	16x9/4x3	YES	YES	-	-	-	-	-
		480i	16x9/4x3	YES	YES	-	-	-	-	-
		S-Video/Video	16x9/4x3	YES	YES	-	-	-	-	-
STROBE	1080i 540p	ANT Digital	16x9	YES	-	-	-	-	-	-
			4x3	-	YES	-	-	-	-	-
		1080i	16x9	-	-	YES	-	-	-	-
		720p	16x9	-	-	-	YES	-	-	-
		480p	16x9/4x3	-	-	-	-	YES	-	-
		480i	16x9/4x3	-	-	-	-	-	YES	-
		S-Video/Video	16x9/4x3	-	-	-	-	-	-	YES

Yes : Available

(-) : Not available

Picture-In-Picture (PIP)

② PAUSE button

If you wish to freeze the sub-picture, press the PAUSE button. This is convenient when trying to write down the address for a mail order company, recording statistics for a sporting event, etc. To return the picture to motion, press the EXIT button. Press the PAUSE button repeatedly to toggle between FREEZE modes (Main Freeze, SPLIT and STROBE).

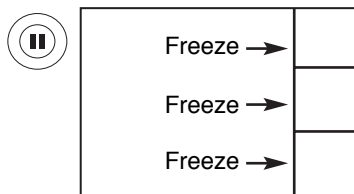

MAIN FREEZE

Press the PAUSE button to freeze one frame of the picture you are currently viewing and the frozen frame will show in the Main Picture. Press the EXIT button to return to normal viewing. This feature is useful for freezing a picture frame with addresses.



SPLIT FREEZE

Press the PAUSE button to freeze the picture you are currently viewing (only the right sub-picture will freeze). Press the EXIT button to return to normal viewing.

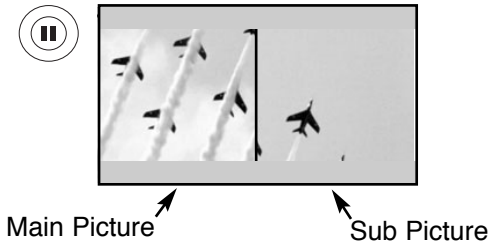

STROBE FREEZE

Press the PAUSE button to freeze three frames of the picture you are currently viewing (only the 3 sub-pictures will freeze). Press the EXIT button to return to normal viewing. This feature is useful for viewing a moving picture that has many details, for example, a close play in a sporting event or a golf swing.

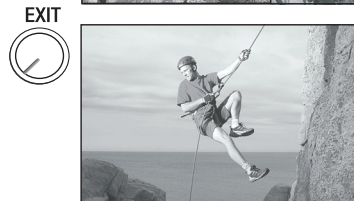
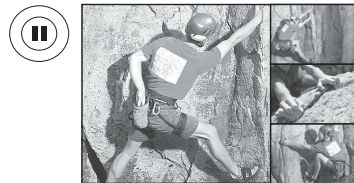

NOTE: 1. The default FREEZE mode is the MAIN freeze followed by the SPLIT freeze and then the STROBE freeze. The last FREEZE mode you selected before you pressed the EXIT button will be the one that comes up after pressing the PAUSE button again.
2. Each freeze frame in Strobe Freeze is delayed about 0.1 (1/10) second.

The Remote Control for Cable Box Functions

OPERATING THE PRECODED FUNCTION FOR YOUR CABLE BOX.

This remote is designed to operate different types of cable boxes. You must first program the remote to match the remote system of your cable box (refer below for pre-codes).

1. Turn **ON** your cable box.
2. Aim the remote control at the front of your cable box.
3. To switch to Cable (CBL) pre-coded mode, press and release the **CABLE (CBL)** button.
4. Hold down the **CBL** button on the remote and enter the two digit preset code that matches your cable box, as shown below. Release the **CBL** button.
5. Aim the remote at the cable box and press the **POWER** button. The remote will turn off your cable box when the correct two digit preset code is entered. When this occurs, the remote control is programmed for your cable box. If the cable box does not turn off, try a different two digit preset code.
6. The remote will now control your Cable box.

NOTE: 1. If your cable box cannot be operated after performing the above procedures, your cable box code has not been precoded into the remote.
 2. In the unlikely event that your cable box cannot be operated after performing the above procedures, please consult your cable box operating guide.
 3. The remote control will remember the codes you have programmed until the batteries are removed from the remote control. After replacing the batteries repeat the entire programming procedure as stated above.

- 1 CABLE (CBL) button**
This button allows the remote to control your cable box by setting it to CABLE mode.
- 2 PRECODED CABLE BOX buttons**
These buttons transmit the chosen precoded cable codes.
- 3 EXCLUSIVE TV buttons**
These buttons are for operating the TV.

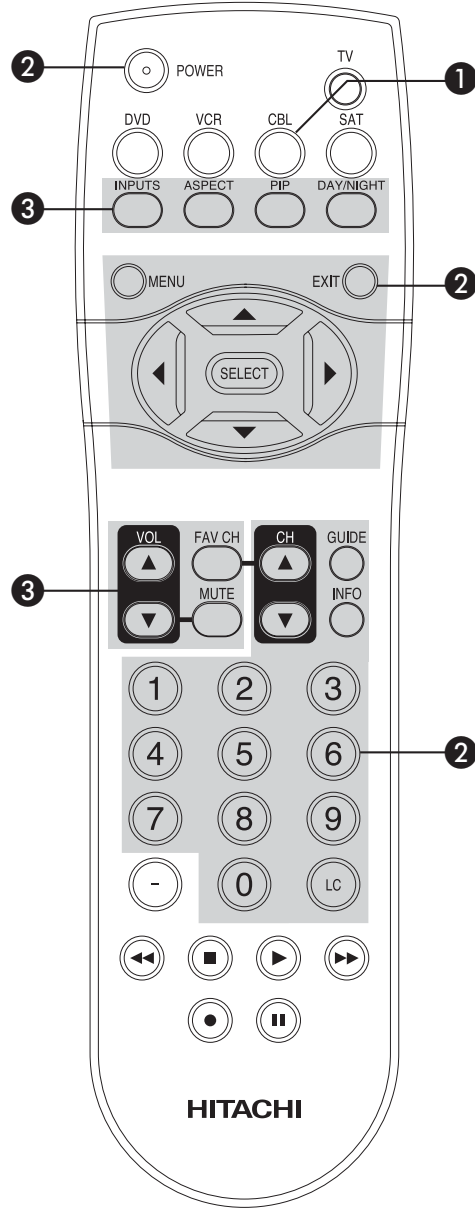

CABLE BRAND Analog Type	CODES
HAMLIN.....	22, 23, 24, 25
JERROLD	00, 01, 02, 03, 04, 05, 06, 07, 21
OAK.....	26, 27, 28
PANASONIC.....	18, 19, 20
PIONEER.....	13, 14
SCIENTIFIC ATLANTA.....	08, 09, 10
TOCOM	15, 16
ZENITH.....	11, 12
G.I.	17

CABLE BRAND DIGITAL TYPE	CODES
PIONEER.....	29
SCIENTIFIC ATLANTA	30

MY CABLE BOX CODE IS: _____

NOTE: Refer to instruction manual of the Cable Box for operation of the buttons exclusively for the Cable Box.

The Remote Control for Set-Top Box/Satellite Receiver Functions

OPERATING THE PRECODED FUNCTION FOR YOUR SET-TOP-BOX/SATELLITE RECEIVER.

This remote is designed to operate different types of set-top-box/satellite systems. You must first program the remote to match the remote system of your set-top-box/satellite systems (refer below for pre-codes).

1. Turn **ON** your set-top-box/satellite systems.
2. Aim the remote control at the front of your set-top-box/satellite systems.
3. To switch to set-top-box/satellite (STB) pre-coded mode, press and release the **SAT** button.
4. Hold down the **SAT** button on the remote and enter the two digit preset code that matches your set-top-box/satellite receiver, as shown below. Release the **SAT** button.
5. Aim the remote at the set-top-box/satellite receiver and press the **POWER** button. The remote will turn off your set-top-box/satellite receiver when the correct two digit preset code is entered. When this occurs, the remote control is programmed for your set-top-box/satellite receiver. If the set-top-box/satellite receiver does not turn off, try a different two digit preset code.
6. The remote will now control your set-top-box/satellite receiver.

NOTE: 1. If your set-top-box/satellite receiver cannot be operated after performing the above procedures, your set-top-box/satellite receiver code has not been pre-coded into the remote.
 2. In the unlikely event that your set-top-box/satellite receiver cannot be operated after performing the above procedures, please consult your set-top-box/satellite receiver operating guide.
 3. The remote control will remember the codes you have programmed until the batteries are removed from the remote control. After replacing the batteries repeat the entire programming procedure as stated above.

- 1 **SAT (Set-Top-Box/Satellite) button**
This button allows the remote to control your set-top-box/satellite receiver by setting it to SET-TOP-BOX/SATELLITE mode.
- 2 **PRE-CODED SET-TOP-BOX/SATELLITE RECEIVER buttons**
These buttons transmit the chosen pre-coded set-top-box/satellite codes.
- 3 **EXCLUSIVE TV buttons**
These buttons are for operating the TV.

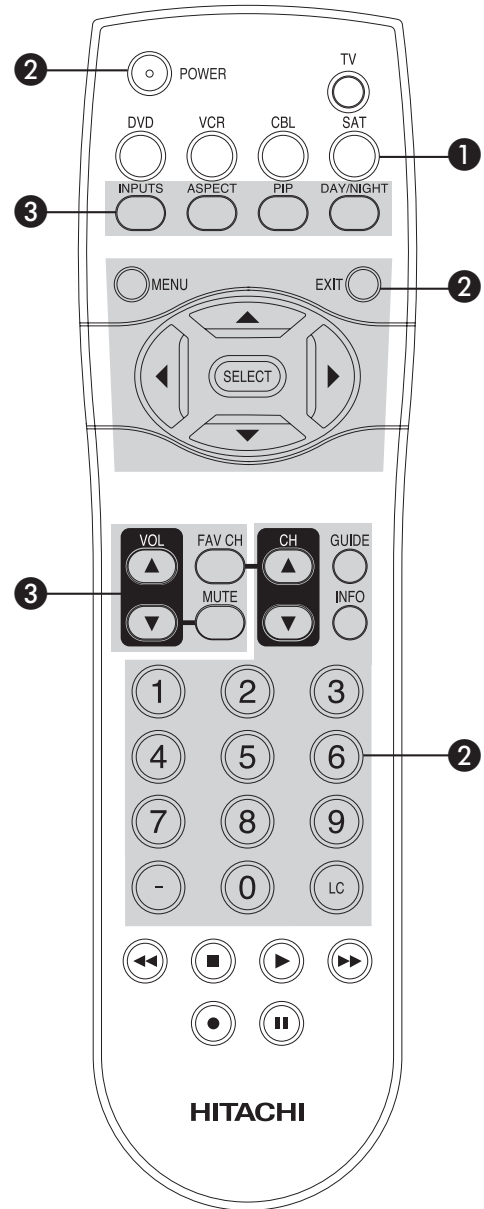

SATELLITE BRAND	CODES
ECOSTAR03
HITACHI.....	00
HUGHES04
RCA01
SONY02

SET TOP BOX BRAND	CODES
PANASONIC05
RCA.....	06
SAMSUNG07
ZENITH.....	.08

MY SATELLITE RECEIVER/ SET TOP BOX CODE IS: _____

NOTE: Refer to instruction manual of the set-top-box/satellite receiver for operation of the buttons exclusively for the set-top-box/satellite receiver.

The Remote Control for DVD Functions

OPERATING THE PRECODED FUNCTION FOR YOUR DVD PLAYER.

This remote is designed to operate different types of DVD players. You must first program the remote to match the remote system of your DVD player (refer below for pre-codes).

1. Turn **ON** your DVD player.
2. Aim the remote control at the front of your DVD player.
3. To switch to DVD pre-coded mode, press and release the **DVD** button.
4. Hold down the **DVD** button on the remote and enter the two digit preset code that matches your DVD player, as shown below. Release the **DVD** button.
5. Aim the remote at the DVD player and press the **POWER** button. The remote will turn off your DVD player when the correct two digit preset code is entered. When this occurs, the remote control is programmed for your DVD player. If the DVD player does not turn off, try a different two digit preset code.
6. The remote will now control your DVD player.
7. You will need to set the display type of your DVD player to **16:9 WIDESCREEN**.

NOTE: 1. If your DVD player cannot be operated after performing the above procedures, your DVD player's code has not been precoded into the remote.
 2. In the unlikely event that your DVD player cannot be operated after performing the above procedures, please consult your DVD player operating guide.
 3. The remote control will remember the codes you have programmed until the batteries are removed from the remote control. After replacing the batteries repeat the entire programming procedure as stated above.

- ❶ **DVD button**
This button allows the remote to control your DVD player by setting it to DVD mode.
- ❷ **PRECODED DVD Buttons**
These buttons transmit the chosen precoded DVD codes.
- ❸ **EXCLUSIVE TV Buttons**
These buttons are for operating the TV.

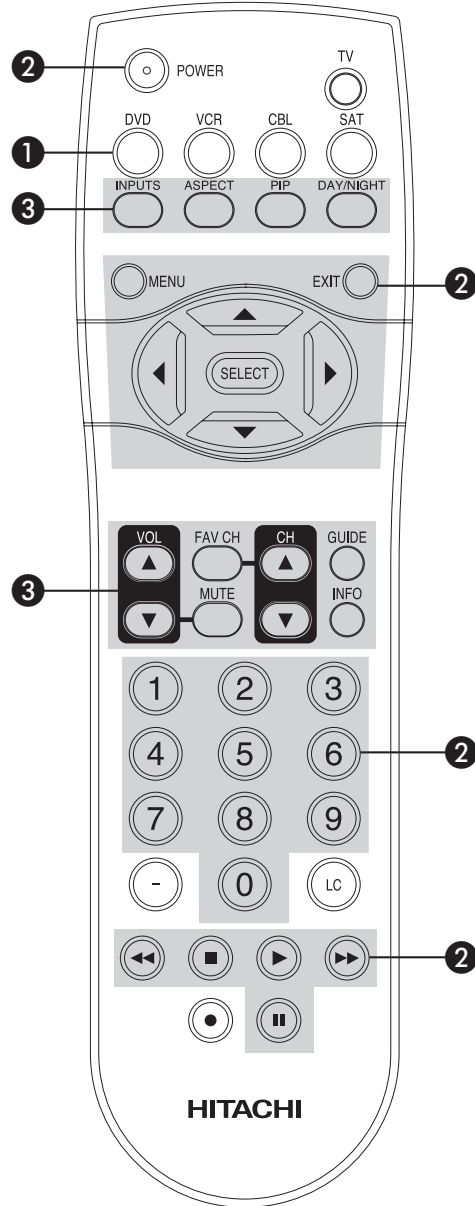

DVD BRAND	CODES
APEX	10
GO VIDEO	09
HITACHI	00
KENWOOD	11
PANASONIC	02
PIONEER	03
RCA	04
SAMSUNG	06
SANYO	07
SONY	01
TOSHIBA	05

MY DVD PLAYER CODE IS: _____

NOTE: Refer to instruction manual of the DVD player for operation of the buttons exclusively for the DVD player.

The Remote Control for VCR Functions

OPERATING THE PRECODED FUNCTION FOR YOUR VCR.

This remote is designed to operate different types of VCRs. You must first program the remote to match the remote system of your VCR (refer below for pre-codes).

1. Turn **ON** your VCR.
2. Aim the remote control at the front of your VCR.
3. To switch to VCR pre-coded mode, press and release the **VCR** button.
4. Hold down the **VCR** button on the remote and enter the two digit preset code that matches your VCR, as shown below. Release the **VCR** button.
5. Aim the remote at the VCR and press the **POWER** button. The remote will turn off your VCR when the correct two digit preset code is entered. When this occurs, the remote control is programmed for your VCR. If the VCR does not turn off, try a different two digit preset code.
6. The remote will now control your VCR.

NOTE: 1. If your VCR cannot be operated after performing the above procedures, your VCR's code has not been precoded into the remote.
 2. In the unlikely event that your VCR cannot be operated after performing the above procedures, please consult your VCR operating guide.
 3. The remote control will remember the codes you have programmed until the batteries are removed from the remote control. After replacing the batteries repeat the entire programming procedure as stated above.
 4. Press the Record button twice to record.

- 1 VCR button**
This button allows the remote to control your VCR player by setting it to VCR mode.
- 2 PRECODED VCR Buttons**
These buttons transmit the chosen precoded VCR codes.
- 3 EXCLUSIVE TV Buttons**
These buttons are for operating the TV.

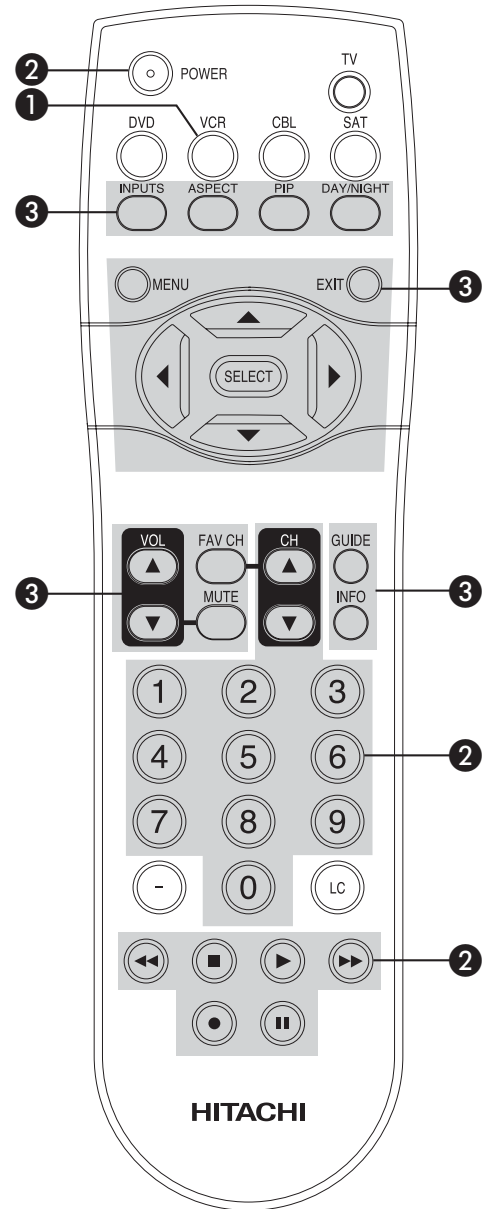

VCR BRAND	CODES
EMERSON	20, 21, 22, 23, 24
FISHER	34, 37, 38, 39
FUNAI.....	52
GE	33
HITACHI	00, 01, 02, 03, 04, 05, 06
JVC.....	49, 50, 51, 18
MAGNAVOX	12, 13, 14
MITSUBISHI.....	27, 28, 29, 30
NEC.....	40, 41
PANASONIC.....	10, 11
SAMSUNG	25, 26, 17
SHARP	31, 32
SONY	07, 08, 09
TOSHIBA.....	15
ZENITH	35

MY VCR PLAYER CODE IS: _____

NOTE: Refer to instruction manual of the VCR for operation of the buttons exclusively for the VCR.

On-Screen Display

1. Press **MENU** on the remote control to display the different features on your **HITACHI** LCD Rear Projection TV.
2. Use the **CURSOR PAD** (buttons **▲**, **▼**, **◀** and **▶**) to navigate and highlight a different feature of the On-Screen Display menu. Press the **SELECT** button to select.
3. Press **EXIT** on the remote control to quickly exit from a menu.

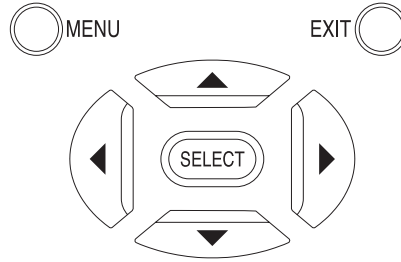

This part of the screen shows which selections are available.

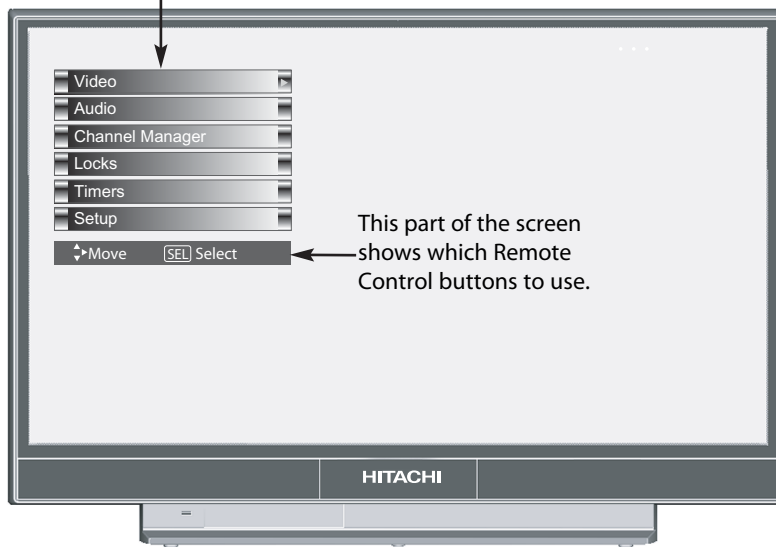

On-Screen Display

Video

Picture Mode	Select between 3 pictures modes; Day Dynamic, Day Normal and Night.
Contrast	Adjust contrast.
Brightness	Adjust brightness.
Color	Adjust color.
Tint	Adjust tint.
Sharpness	Adjust sharpness.
Color Temperature	Set this to High for less intense color with more blue, set to Medium for natural color, set to Standard for standard colors
Black Enhancement	Enhance picture brightness in light scenes.
Contrast Mode	Use this function to choose between 2 Contrast Mode settings.
Noise Reduction	Reduces conspicuous noise in the picture.
Auto Movie Mode	Turn On/Off the 3:2 Pulldown detection feature.
Black Side Panel	Set the gray side bars On/Off when watching 4:3 signals in standard mode.
Aspect	Choose the picture format aspect ratio.
Reset Video Settings	Choose to Reset Video Settings to factory settings.

Audio

Treble	Adjust the treble.
Bass	Adjust the bass.
Balance	Adjust the balance.
Surround	Select Surround settings (Off, Wide, Normal)
Bass Boost	Select Bass Boost option ON or OFF.
Audio Source	Select between three Audio Sources.
Internal Speakers	Select internal or external speakers.
Auto Noise Cancel	Eliminates the noise between stations.
Perfect Volume	Adjust volume in fixed setting.
Loudness	Adjust Loudness.
Language	Select Language options if available.
Digital Output	Select Optical Output options.
DRC	Select Dynamic Range Compression to ON or OFF.

NOTE: The Language, Digital Output, and the Dynamic Range Compression feature of the Audio OSD are only available for Digital channels.

Channel Manager

Signal Meter	Access Signal Meter.
Auto Channel Scan	Set Auto Channel Scan.
Channel List	Set Channel List.

Locks

Change Access Code	Change Lock access code.
Engage Lock	Choose to lock channel, and/or Side panel.
Movie Ratings	Block various types of movies and video types based on motion picture ratings.
TV Ratings	Block various types of movies and television programming based on a parental guide ratings.
Canadian Ratings (ENG)	Block various types of movies and television programming based on the Canadian ratings system.
Canadian Ratings (FRN)	Block various types of movies and television programming based on the Canadian French ratings system.
Alternate Ratings U.S.	Ratings system for DTV Signal to block various types of programs

Timers

Set the Clock	Set Clock Settings.
Set Sleep Timer	Set Sleep Timer intervals (30 min. intervals, 00:30-3:00).
Set Day/Night Timer	Set Day/Night picture mode settings.
Set Event Timer	Set viewing reservation for TV programs.

Setup

Set The Menu Options	Choose English, French, or Spanish text and Background.
Set The Power Saving	Automatic Power Saving features.
Set The Inputs	Label Video Inputs, VCR, DVD, etc.
Set The Closed Captions	Feature to display dialogue/text.
Set The Output Terminals	Set Output source options.
CableCARD Information	Access important CableCARD and Diagnostics info.
Set The Quick Start Options	Select the TV Quick Start Up options.
Reset The Software	Select to upgrade TV software.

NOTE: 1. The Signal Meter feature of the Channel Manager OSD is only available for Digital channels.
2. The CableCARD information feature of the Setup OSD is only available when a CableCARD from your cable operator is installed in the rear panel of the TV.

Video

Select VIDEO to adjust picture settings and improve picture quality. You can independently customize each of the Video Inputs to your preference to increase viewing performance and pleasure depending upon the video program being viewed. If RESET is selected, only the selected input will reset to initial conditions.

Picture Mode

Use this function to choose from automatic picture settings to optimize your TV's performance.

1. Use the **CURSOR** buttons ◀ or ▶ to highlight and select **PICTURE MODE** settings (Day-Normal, Day-Dynamic or Night).
2. Then press the **SELECT** button to set the mode and return to the Video menu or press **EXIT** to quit menu.
3. There are 3 Picture Modes available for the customer Day (Dynamic) , Day (Normal) and Night mode. Day (Dynamic) is the original factory preset mode , this can be changed by adjusting any video setting to your desire conditions. Day (Normal) can be used as a second video setting for daytime viewing. Night is set to watch programing during nighthtime.

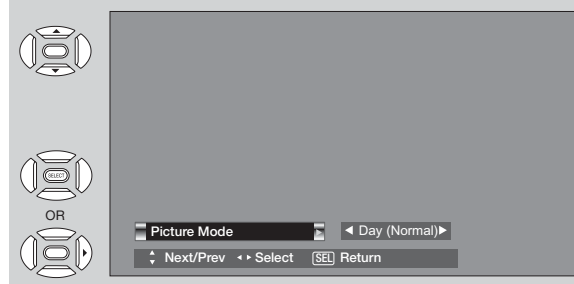
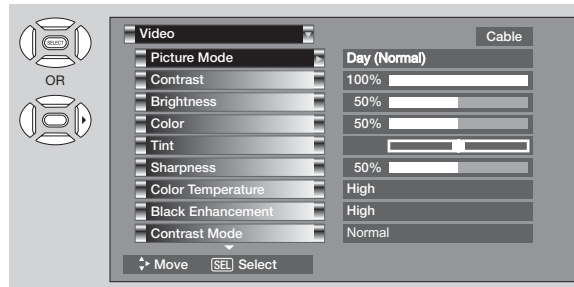
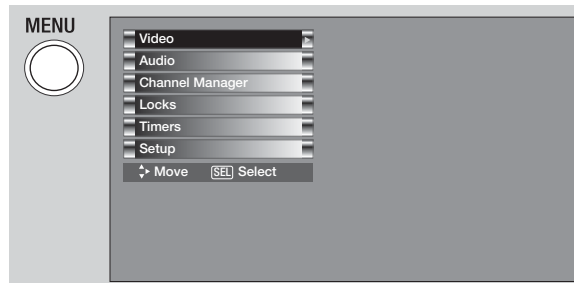

1. Use the **CURSOR PAD** ▲ or ▼ to highlight the function to be adjusted.
2. Press the **SELECT** button or the CURSOR PAD ▶ to select the function settings.
3. Press the **CURSOR PAD** ◀ or ▶ to adjust the function.
4. Press **MENU** to return to main menu.
5. Press **EXIT** to quit menu.

Contrast

Use this function to change the contrast between black and white levels in the picture.

Brightness

Use this function to adjust overall picture brightness.

Color

Use this function to adjust the level of color in the picture.

Tint

Use this function to adjust flesh tones so they appear natural.

Sharpness

Use this function to adjust the amount of fine detail in the picture.

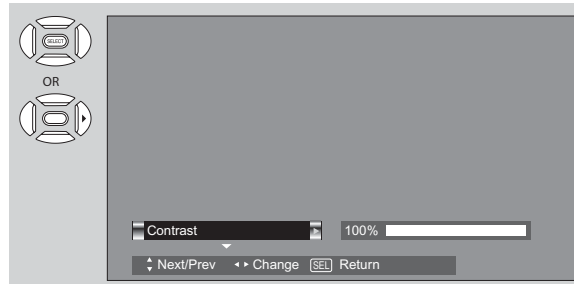

Video

Color Temperature

Set this to High for cooler color with more blue, set to Medium for more natural color, set to Standard for accurate color .

Black Enhancement

Use this function to enhance the shadow detail in dark scenes using the settings off, low, middle and high.

- NOTE:** 1. If **CONTRAST** is selected, you are adjusting **CONTRAST**. The additional menu items **BRIGHTNESS**, **COLOR**, **TINT**, and **SHARPNESS** can be selected and adjusted in the same manner.
2. It may be necessary to adjust **TINT** to obtain optimum picture quality when using the **COMPONENT VIDEO Y-PbPr** input jacks.
3. **CABLE** and **AIR** share a Video setting. Also, each of the video inputs have their own independent settings.

Contrast Mode

Use this function to choose between 2 Contrast Mode settings. Set to Dynamic for darker images more in the level of Black, set to Normal for a balanced White to Black level.

Noise Reduction

The **NOISE REDUCTION** function automatically reduces conspicuous noise in the picture without degrading picture quality. Set **NOISE REDUCTION** to **OFF** if the TV experiences picture blocking.

Auto Movie Mode

The **AUTO MOVIE MODE** function turn ON or OFF the 3:2 PULLDOWN DETECTION SPECIAL FEATURE. Theatrical movies are shot on film at 24 frames or still pictures per second, instead of 30 frames or 60 fields like video. When film is transferred to video for television viewing, the disparity between the two frame rates must be reconciled. This involves a process known as 3:2 pulldown.

When **AUTO MOVIE MODE** is turned ON from the VIDEO menu, your Hitachi LCD Television will activate the circuitry for this special feature to improve video performance when watching film based sources.

- NOTE:** 1. When using Progressive Scan Component (Ex. 480p, 720p, 1080i), Auto Movie Mode will not be available (grayed out).
2. All Video settings are independent of each other based on it's input (Cable/Air, Input 1~5).

Aspect

Use this function to select the Picture Format Aspect Ratio.

Auto Aspect

Automatically adjust the Aspect Ratio depending on the input signal to fill the screen.

Mode

Manually select the Aspect Ratio.

Vertical Position

This function allows you to select when aspect style is either 4:3 EXPANDED/ZOOM1/ZOOM2 or 16:9

ZOOM. Vertical position can be changed with these modes. For example, it will be useful for centering the picture area at both the top and bottom of the picture with 480i/480p signal. Adjustable range is -10 (video center is toward bottom of screen) to +10 (video is toward top of screen).

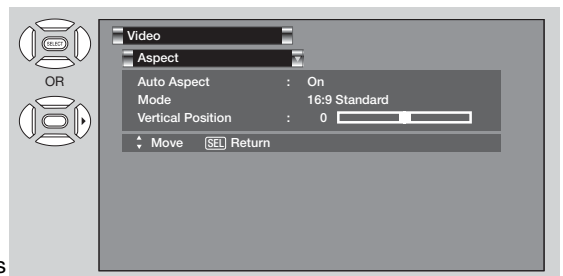

1. Use the **CURSOR PAD ▲** or **▼** to to select menu item.
2. Press the **CURSOR PAD ◀** or **▶** to adjust the function.
3. Press the EXIT to quit the MENU, or select ASPECT to return to the main menu.

NOTE: Vertical Position will not be available in 4:3 Standard and 16:9 Standard mode.

Video

Black Side Panel

The **BLACK SIDE PANEL** function turns the gray side bars on/off when watching 4:3 signals in Standard mode or use of the PIP modes.

1. Press the **CURSOR PAD** ◀ or ▶ to set to ON or OFF.
2. Press **EXIT** to quit menu or select **SET BLACK SIDE PANEL** to return to the previous menu.

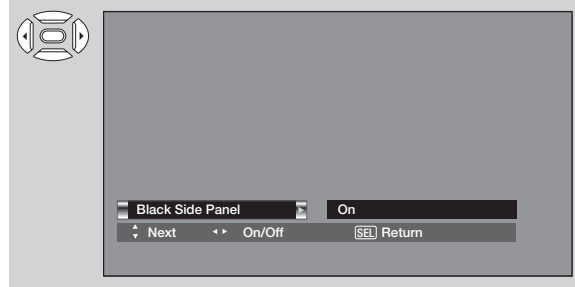
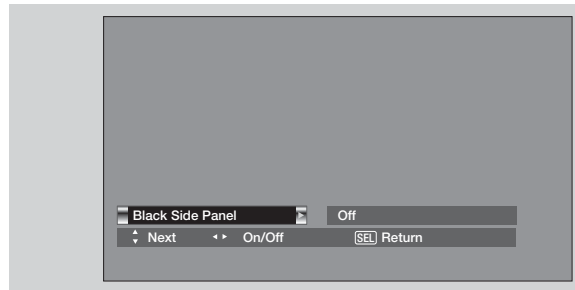

Reset Video Settings

This function allows you to Reset the Video Menu Settings of the present input and return it to the Day-Dynamic VIDEO mode.

1. Use CURSOR PAD ▲, ▼ or CHANNEL UP/DOWN buttons to highlight functions.
2. Press the SELECT button or CURSOR PAD ▶ to select Reset Video Settings.
3. Use the CURSOR PAD ▼ to access at the Reset softkey.
4. Press the SELECT button to Reset the Video Settings.

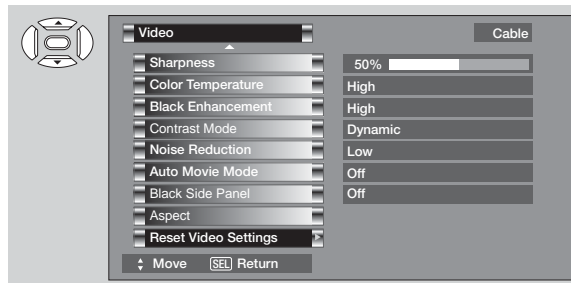

You can customize each of the Video Inputs to your preference to increase viewing performance and pleasure, depending upon the video program being viewed. If RESET is selected, only the selected Input will reset to the initial conditions as explained above.

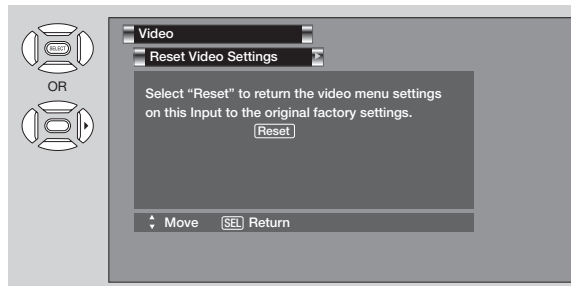

If RESET is selected in Input 1, only Input 1 will return to factory conditions.

Audio



Select AUDIO to adjust the TV to your preference and to improve the sound quality.

1. Press CURSOR PAD ▲ or ▼ to select menu item.
2. Press CURSOR PAD ◀ or ▶ to adjust the function.
3. Press EXIT to quit the MENU, or select AUDIO to return to the main menu.

NOTE: If TREBLE is selected you are adjusting treble. The additional menu items Bass and Balance can be selected and adjusted in the same manner.

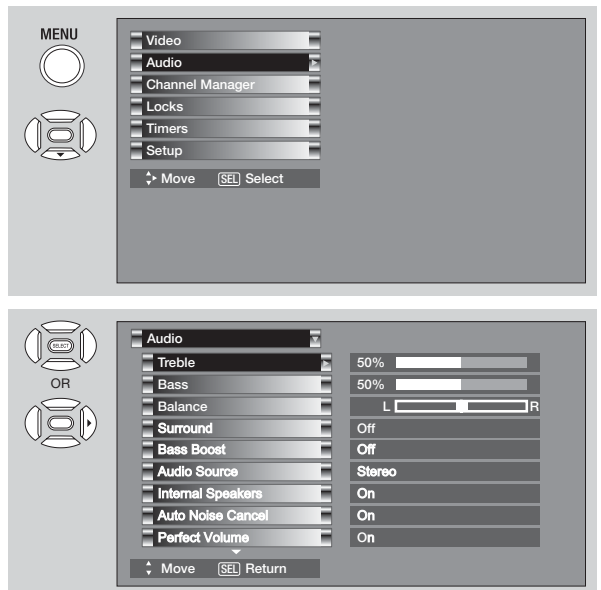

Treble

This function controls the high frequency audio to all speakers.

Bass

This function controls the low frequency audio to all speakers.

Balance

This function will control the left to right balance of the TV internal speakers.

Surround

Surround sound is the concept of expanding the spatial imaging of audio from one dimension (Mono/Left-Right) to two or three dimensions. This is often done to create a more realistic audio environment.

- 1.- Use cursor ▲ or ▼ to highlight surround option.
- 2.- Use cursor ◀ or ▶ to select Off, Normal or Wide.

Off : turns off the surround sound effect.

Normal Surround : Provides the surround effect by locating two or more speakers to the rear of the listener.

Wide Surround : Reproduce much better quality 5 channel sound signals from ordinary stereo contents comparing with normal surround technology. Wide surround enable users to enjoy sound playback in wide surround virtual area like 5 channel contents with ordinary stereo contents.

Bass Boost

This function allows to enhance the low frequency audio performance of your speaker system.

Audio

Audio Source

Multi-Channel Television Sound will allow you to select **STEREO** (a stereo broadcast), **MONO** (monaural sound) used when receiving a weak stereo broadcast or **SECOND AUDIO PROG (SAP)** which may be a secondary language, weather report, etc.

Internal Speakers

This function is useful when setting up the external speakers.

ON	Select this feature if using the internal speakers only.
TV as Center	Select this feature when setting up external speakers from a separate stereo system. The TV's speakers will work as the center speaker.
OFF	Select this feature if you prefer to use only speakers from a separate stereo system.

Auto Noise Cancel

This function eliminates the noise between stations. If a channel is tuned and is noisy, this function will automatically eliminate the audio for that channel.

Perfect Volume

This function will automatically adjust volume so each channel and input has the same average volume level.

Loudness

Set this function to ON to emphasize bass and treble at low volume levels.

Language

Some programs transmit more than one DTV language option. Most will have English as a default language. The language function will allow you to select up to 4 language options (if available).

Digital Output

This function allows you to select between Dolby® Digital and PCM.



Dolby® Digital - Select this feature if the TV is connected to an amplifier/receiver with a Dolby® Digital only decoder; it will provide six independent soundtrack channels through the optical output jack (Digital Audio).

NOTE: *Manufactured under license from Dolby Laboratories. "Dolby" and the double-D symbol are trademarks of Dolby Laboratories.

PCM - Select this feature if the TV is connected to an amplifier/receiver with a PCM only decoder; it will provide two independent soundtrack channels through the optical output jack (Digital Audio).

DRC

Dynamic Range Compression - Use this function to compress the range of sound volume. By compressing the range of sound volume, it is possible not only to suppress the output of loud sound at night but also to raise the volume of low sound. The default setting is ON.

Use the CURSOR PAD ◀ or ▶ to select the chosen options.

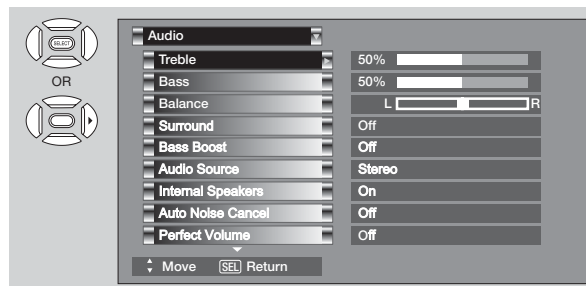

NOTE: The functions Language, Digital Output and DRC are only available when viewing digital programs.

Use the functions at right if your TV is connected to an amplifier/receiver with optical digital input with Dolby Digital or PCM decoder capabilities.

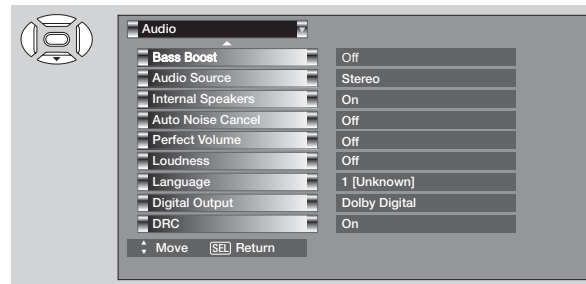

NOTE: 1.- The DRC control affects only Dolby Digital signals decoded internally by the TV.
2.- DRC does not affect the Dolby Digital bitstream available at the digital audio output.

Channel Manager

Channel Manager

Select **CHANNEL MANAGER** to set your Antenna options, run Auto Channel Scan, Check Signal Meter and Set Channel List.

1. Press CURSOR PAD ▲, ▼ or CHANNEL UP/DOWN buttons to highlight function.
2. Press the SELECT button or CURSOR PAD ► to select.

Signal Meter

Select **SIGNAL METER** when using an indoor or outdoor antenna. This feature will show the signal strength and peak values of the Antenna signal to help you adjust your antenna to optimize signal reception.

Use the **CURSOR PADS** and the **SELECT** button to highlight and select **CLOSE** to exit.

NOTE: The Signal Meter will not be available (grayed out) when watching analog channels.

Auto Channel Scan

This feature will automatically store active Analog and Digital channels in Auto Channel Scan memory.

1. Use the **CURSOR** buttons ◀ or ▶ to highlight AIR, CABLE (1) or CABLE(2) source.
2. Press the **CURSOR** buttons ◀ or ▶ to highlight the **START** or **RESET** option.
3. Press the **SELECT** button to select.

- NOTE:**
1. When a CableCARD is installed, Auto Channel Scan will not be available since channels will be fixed based on what was agreed upon by you and your cable operator.
 2. If certain channels are poor or not possible in cable(1) mode, set cable source to cable(2) by using the CURSOR buttons ◀ or ▶.

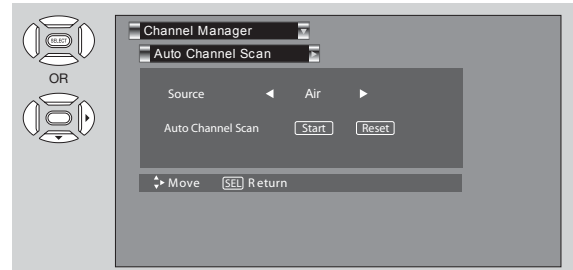
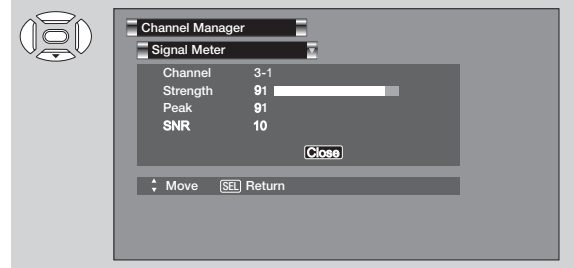

Channel Manager

Channel List

This function allows you to review which channels are labeled **(CH ID)**, which have been added to **CHANNEL MEMORY (SCAN)**, which are protected by **LOCK** and which are your **FAVORITE (FAV) CHANNELS**.

1. Use the **CURSOR PAD** to navigate the Channel List.
2. Press the **SELECT** button to select **ON** or **OFF** on the **SCAN** and **LOCK** columns.
3. To select **LOCK** column, input the access code.
(Default access code: 0000)
4. Press the **FAV** button to set or remove the **FAVORITE** settings.
5. Press the **EXIT** button to return to normal viewing.

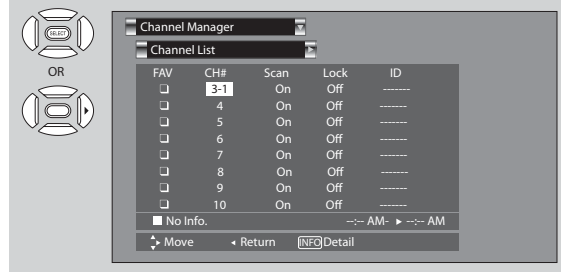
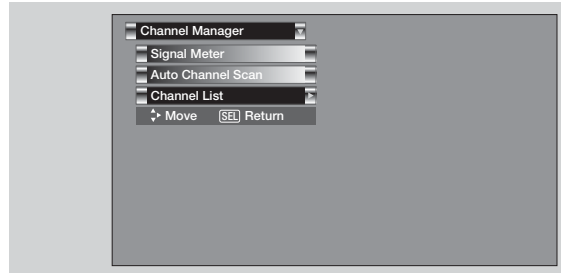

- NOTE:**
1. When a CableCARD is installed, the Channel List will be dependent on channels agreed upon by you and your cable operator.
 2. The Channel List cannot be updated by only changing the cable source. Auto Channel Scan must be performed for the Channel List to be updated.

Locks

Locks

This function will block out the picture and sound of the selected channel or video input.

The code to enter the Locks feature is a four digit access code number. The factory preset code is **0000**. Use the **NUMBER** buttons to enter the access code.

1. Use the **CURSOR PAD ▲, ▼** or **CHANNEL UP/DOWN** buttons to highlight the desired function in the **LOCKS** menu.
2. Press the **SELECT** button to select.

Change Access Code

1. To change the **ACCESS CODE NUMBER**, select **CHANGE ACCESS CODE** to change the factory preset code (**0000**) to your preference.

If you forget your **ACCESS CODE NUMBER**, use the factory code **7777** to erase your key number. This will reset the access code number back to the factory preset (**0000**).

2. Enter a new four digit number.
3. Press **EXIT** to quit the menu.

Engage Lock

When **ENGAGE LOCK** is selected, **SET CHANNEL LOCK** and **SET FRONT PANEL LOCK** can be set individually.

When **SET CHANNEL LOCK** is turned on, the picture and sound for the chosen channel will be blocked out.

When **FRONT PANEL LOCK** is turned on, all buttons on the Front Panel will be deactivated, except the **POWER** button.

When **MOVIE RATINGS** is selected, you can block various types of movies and video tapes based on motion picture ratings. Picture-in-Picture will also be blocked automatically (see page 41).

When **TV RATINGS** is selected, various types of television programming based on a parental guide ratings will be blocked. Picture-in-Picture will also be blocked automatically (see page 42).

Use **CANADIAN RATINGS** to block various types of movies and television programs based on the two rating systems used in Canada that you feel may be inappropriate due to its content (see pages 43-44).

Use **ALTERNATE RATINGS (U.S.)** to block various types of movies and television programs based on ratings systems used in U.S. that you feel may be inappropriate due to its content (see page 45).

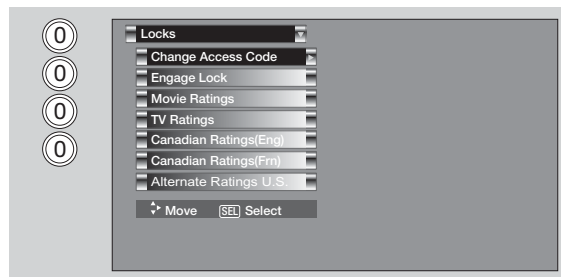
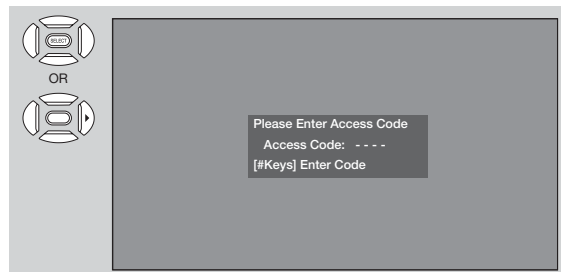
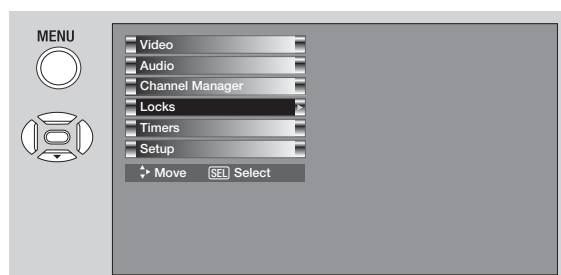

NOTE:

The **ALTERNATE RATINGS (U.S.)** option is available for Digital Channels only.

Locks

Movie Ratings

Use Movie Ratings to prevent viewing of any movie that you feel may be inappropriate due to its content.

1. Use the CURSOR PAD ▲, ▼ or **CHANNEL UP/DOWN** buttons to select the **MOVIE RATING** category that you want to block.
2. Press **SELECT** to block the **MOVIE RATING** that you have selected. Once rating is selected, for example PG-13, all movies rated PG-13 and higher (R, NC-17, and X) will be blocked.
3. Press **EXIT** to quit the menu or select **MOVIE RATING** to return to the previous menu.

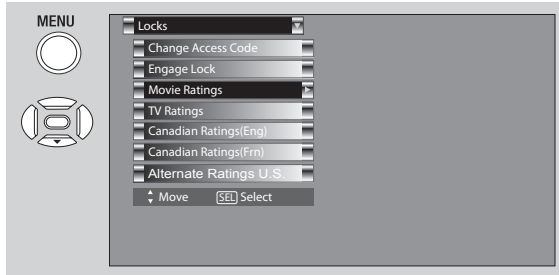

Motion Picture Ratings Table

NOT RATED	Contains no rating. Not Rated (NR) and Not Applicable (NA) programs. Movie has not been rated or ratings do not apply.
G	General audiences. All ages admitted.
PG	Parental guidance suggested. Some material may not be suitable for children.
PG-13	Parents strongly cautioned. Some material may be inappropriate for children under 13.
R	Restricted. Under 17 requires accompanying parent or adult guardian.
NC-17	No one 17 and under admitted.
X	Adults only

- NOTE:**
1. A movie rating is dependent upon the movie that is viewed. If the movie does not carry a rating, the TV will not block it.
 2. Blocking **NOT RATED** programs may block emergency programming, sports, news, public service announcements, religious programs and weather.
 3. If a CableCARD is installed, your cable operator may provide an Emergency Alert System (EAS) message in the event of a local or national emergency with the purpose of alerting the general public. When you receive such messages, the Television will immediately tune to an EAS channel as directed by the EAS message. Please be advised that if the EAS channel is blocked using the **LOCKS** feature, you will not be able to tune to that channel.

Locks

TV Ratings

Use **TV RATINGS** to prevent the viewing of any TV program that you feel may be inappropriate due to its content.

1. Use the **CURSOR PAD ▲, ▼** or **CHANNEL UP/DOWN** buttons to select the **TV RATING** category that you want to block.
2. Press **SELECT** to block the **TV RATING** that you have selected.
3. Press **EXIT** to quit the menu or select **TV RATING** to return to the previous menu.

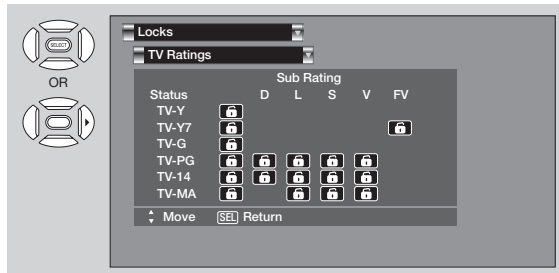
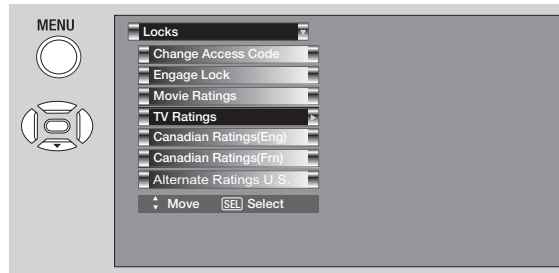

TV Parental Guide Ratings Table

TV-Y	All children. The themes and elements in this program are specifically designed for a very young audience, including children from ages 2-6.
TV-Y7	Directed to older children. Themes and elements in this program may include mild physical or comedic violence, or may frighten children under the age of 7.
TV-G	General audience. It contains little or no violence, no strong language, and little or no sexual dialogue or situations.
TV-PG	Parental guidance suggested. The program may contain infrequent coarse language, limited violence, some suggestive sexual dialogue and situations.
TV-14	Parents strongly cautioned. This program may contain sophisticated themes, intense sexual situation, more intense violence and intensely suggestive dialogue.
TV-MA	Mature audiences only. This program may contain mature themes, indecent language, graphic violence, and explicit sexual content.
FV	Fantasy Violence
V	Violence
S	Sexual Situation
L	Adult Language
D	Sexually Suggestive Dialogue

- NOTE:**
1. If you Block **TV-14D**, you will still permit **TV-MA** programs; If you block **TV-14V**, you will automatically block **TV-MAV** programs, but you will still permit **TV-MALS** programs. This means that the TV will block violence in **TV-14** and higher (**TV-MA**), but not language and sex.
 2. TV program ratings are dependent on the broadcaster. If the program is not rated, the TV will not block it.
 3. If a CableCARD is installed, your cable operator may provide an Emergency Alert System (**EAS**) message in the event of a local or national emergency with the purpose of alerting the general public. When you receive such messages, the Television will immediately tune to an **EAS** channel as directed by the **EAS** message. Please be advised that if the **EAS** channel is blocked using the **LOCKS** feature, you will not be able to tune to that channel.

Locks

Canadian Ratings (Eng)

Use **CANADIAN RATINGS (ENG)** to block any type of movie and television program in Canada that you feel might be inappropriate in its content.

1. Use the **CURSOR PAD ▲, ▼** or **CHANNEL UP/DOWN** buttons to select the **CANADIAN RATINGS (ENG)** category that you want to block.
2. Press **SELECT** to block the **CANADIAN RATINGS (ENG)** that you have selected. Once rating is selected, for example **C8+**, all movies and television programs rated **C8+** and higher (**G, PG, 14+** and **18+**) will be blocked automatically.
3. Press **EXIT** to quit the menu or select **CANADIAN RATINGS (ENG)** to return to the previous menu.

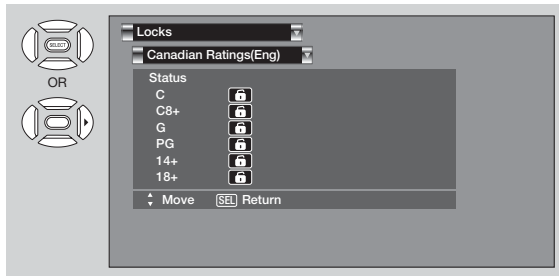

Canadian Ratings English Table

C	Programming intended for children under age 8 - Violence Guidelines: Careful attention is paid to themes, which could threaten children's sense of security and well-being. There will be no realistic scenes of violence. Depictions of aggressive behaviour will be infrequent and limited to portrayals that are clearly imaginary, comedic or unrealistic in nature. Other Content Guidelines: There will be no offensive language, nudity or sexual content.
C8+	Programming generally considered acceptable for children 8 years and over to watch on their own - Violence Guidelines: Violence will not be portrayed as the preferred, acceptable, or only way to resolve conflict; or encourage children to imitate dangerous acts which they may see on television. Any realistic depictions of violence will be infrequent, discreet, of low intensity and will show the consequences of the acts. Other Content Guidelines: There will be no profanity, nudity or sexual content.
G	General Audience - Violence Guidelines: Will contain very little violence, either physical or verbal or emotional. Will be sensitive to themes which could frighten a younger child, will not depict realistic scenes of violence which minimize or gloss over the effects of violent acts. Other Content Guidelines: There may be some inoffensive slang, no profanity and no nudity.
PG	Parental Guidance - Programming intended for a general audience but which may not be suitable for younger children. Parents may consider some content inappropriate for unsupervised viewing by children ages 8-13. Violence Guidelines: Depictions of conflict and/or aggression will be limited and moderate; may include physical, fantasy, or supernatural violence. Other Content Guidelines: May contain infrequent mild profanity, or mildly suggestive language. Could also contain brief scenes of nudity.
14+	Programming contains themes or content which may not be suitable for viewers under the age of 14 - Parents are strongly cautioned to exercise discretion in permitting viewing by pre-teens and early teens. Violence Guidelines: May contain intense scenes of violence. Could deal with mature themes and societal issues in a realistic fashion. Other Content Guidelines: May contain scenes of nudity and/or sexual activity. There could be frequent use of profanity.
18+	Adult - Violence Guidelines: May contain violence integral to the development of the plot, character or theme, intended for adult audiences. Other Content Guidelines: May contain graphic language and explicit portrayals of nudity and/or sex.

Locks

Canadian Ratings (Frn)

Use **CANADIAN RATINGS (FRN)** to block Canadian French programs according to various program ratings that you feel might be inappropriate in its content.

1. Use the **CURSOR PAD ▲, ▼** or **CHANNEL UP/DOWN buttons** to select the **CANADIAN RATINGS (FRN)** category that you want to block.
2. Press **SELECT** to block the **CANADIAN RATINGS (FRN)** that you have selected. Once rating is selected, for example **8 ANS+**, all movies and television programs rated **8 ANS+** and higher will be blocked automatically.
3. Press **EXIT** to quit the menu or select **CANADIAN RATINGS (FRN)** to return to the previous menu.

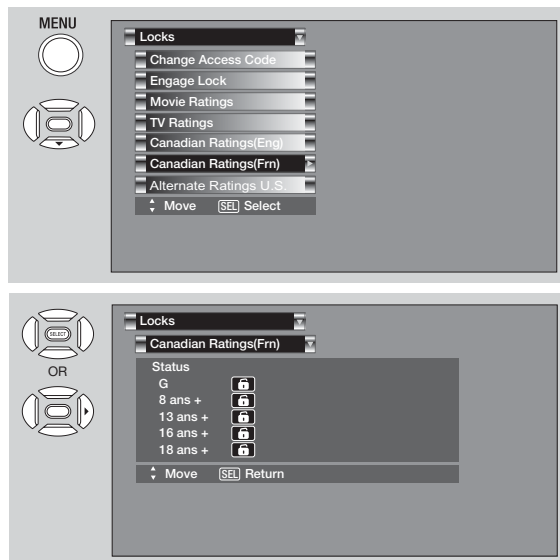

Canadian Ratings French Chart

G	General - Programming intended for audiences of all ages. Contains no violence, or the violence content is minimal or is depicted appropriately with humor or caricature or in an unrealistic manner.
8 ans +	8 + General - Not recommended for young children - Programming intended for a broad audience but contains light or occasional violence that could disturb young children. Viewing with an adult is therefore recommended for young children (under the age of 8) who cannot differentiate between real and imaginary portrayals.
13 ans +	Programming may not be suitable for children under the age of 13 - Contains either a few violent scenes or one or more sufficiently violent scenes to affect them. Viewing with an adult is therefore strongly recommended for children under 13.
16 ans +	Programming is not suitable for children under the age of 16 - Contains frequent scenes of violence or intense violence.
18 ans +	Programming restricted to adults - Contains constant violence or scenes of extreme violence.

Locks

Alternate Ratings U.S.

Use Alternate Ratings to prevent viewing of any movie or program that you feel may be inappropriate due to its content. This feature will be available only for ATSC Digital signal.

In case only NTSC analog signal is received this feature will be unavailable (grayed out).

In order to set the Alternate Ratings the ATSC Digital channel received must include Alternate Ratings data. To see if the channel has Alternate Ratings, press the INFO key on the R/C. See fig. (1) for reference.

Once the TV has received Alternate Ratings data, the Alternate Ratings US in the lock menu will become available.

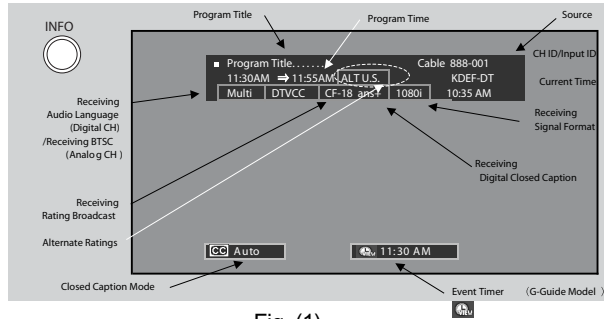
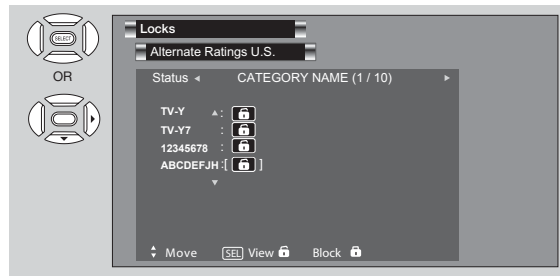

Fig. (1)

1. Use the CURSOR buttons ▼ or ▲ to select the **ALTERNATE RATING** category that you want to block.



2. Press **SELECT** to block the **ALTERNATE RATING** that you have selected. Once rating is selected, for example PG-13, all movies rated PG-13 and higher (R, NC-17 and X) will be blocked.



3. Press **EXIT** to quit the menu or select **ALTERNATE RATINGS** to return to the previous menu.

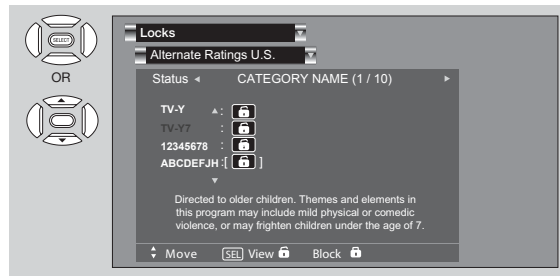

Alternate Ratings (Example Only) :

G	General audiences. All ages admitted.
PG	Parental guidance suggested. Some material may not be suitable for children.
PG-13	Parents strongly cautioned. Some material may be inappropriate for children under 13.
R	Restricted. Under 17 requires accompanying parent or adult guardian.
NC-17	No one 17 and under admitted.
X	Adults only
Y	Adults only

NOTE: In some cases the OSD will show the function name as " Alternate Ratings U.S. " or "Downloaded Ratings ", in both cases the operation is the same, only name is different.

Timers

Timers

Select **TIMERS** to set your Clock, Sleep Timer, Event Timer and Day/Night Timer.

1. Use the **CURSOR** buttons ▲ or ▼ to highlight the function to be adjusted.
2. Press the **SELECT** button to select.

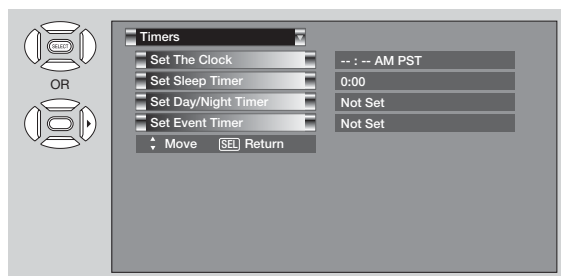

Set The Clock

The Clock must be adjusted before you can use the **SET EVENT TIMER** or **DAY/NIGHT TIMER** feature.

1. Use the **CURSOR PAD** ◀, ▶, ▲, ▼ or **CHANNEL UP/DOWN** buttons to highlight the chosen **TIME ZONE** settings.
2. Press the **SELECT** button to select. If you observe daylight savings, use **CURSOR PAD** to highlight **DAYLIGHT SAVING CORRECTION** and press the **SELECT** button to select.
3. Use the **CURSOR PAD** ◀, ▶, ▲, ▼ or **CHANNEL UP/DOWN** buttons to highlight the **CURRENT TIME** hour and minute), **AM** or **PM**, **MONTH**, **DAY**, and **YEAR**.
4. Use the **CURSOR PAD** ▲, ▼ to adjust settings.
5. Press the **SELECT** button to set the **TIME AND DATE**.
6. Press **EXIT** to quit the menu or select **SET THE CLOCK** to return to the previous menu.

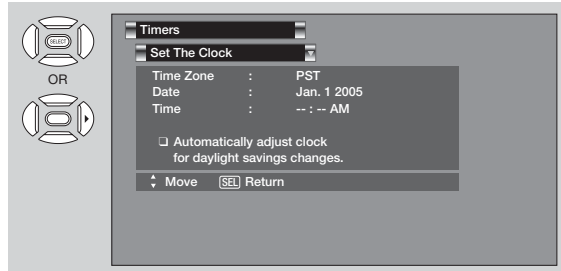
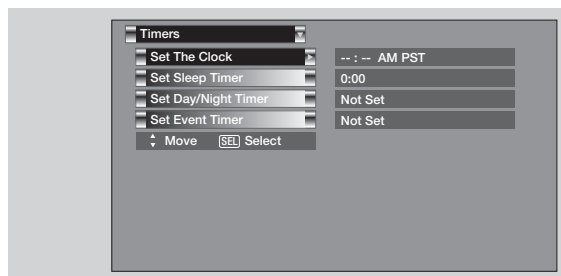

NOTE: 1. When **AUTOMATICALLY ADJUST CLOCK FOR DAYLIGHT SAVING CHANGES** is checked ✓, the TV will automatically calculate the clock adjustment for Daylight Saving.
 2. When the CableCARD is used, the TV will **SET THE CLOCK** automatically.
 3. The TV counts electrical pulses for regulating the **TIMERS**. When the power cord is unplugged then plugged in quickly, the clock is stopped momentarily and the **TIME** indication will become slow.

Timers

Set Sleep Timer

Select this feature to set your **SLEEP TIMER** from 30 minutes to 3 hours (30 minute increments).

1. Press the **CURSOR PAD** ► repeatedly to set your Timer from **0:00**, **0:30**, **1:00**, **1:30**, **2:00**, **2:30** and **3:00**.

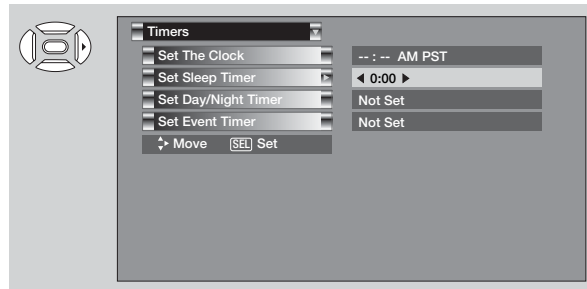
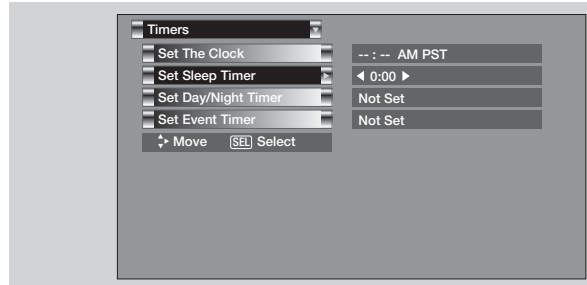

Set Day/Night Timer

Select this feature to activate and set your TV's **DAY/NIGHT PICTURE MODE** automatically. This feature is not available until the clock is set.

1. Use the **CURSOR PADS** to highlight **SET DAY/NIGHT TIMER** settings.
2. Press the **SELECT** button to select.
3. Use the **CURSOR PADS** to select **DAY MODE ON** and to set its **TIMER**.
4. Use the **CURSOR PADS** to select **DAY MODE OFF** and to set its **TIMER**.
5. Press **EXIT** to quit the menu or select **SET DAY/NIGHT TIMER** to return to the previous menu.

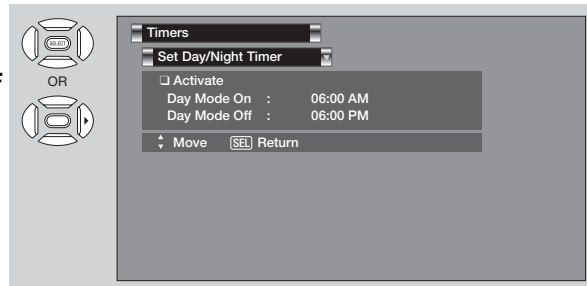
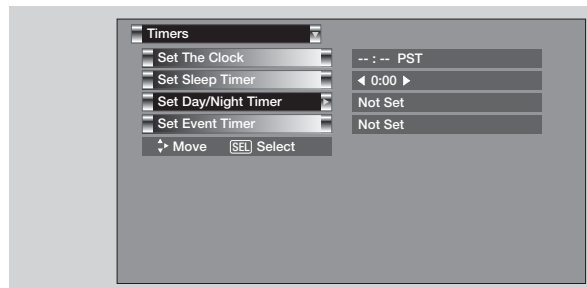

Timers

Set Event Timer

This function will automatically operate the LCD TV viewing reservation of a program. If the clock is not set, you can not use this function and the screen below will appear. The message on the screen will disappear after 3 seconds, then the screen automatically goes to the clock setup mode (see page 46).



1. Use the **CURSOR PAD ▲, ▼** to highlight **EVENT 1, EVENT 2, EVENT 3, EVENT 4** and then press the **SELECT** button to select.
2. Use the **CURSOR PAD ▲, ▼** or **▼** to highlight and select **START TIME HOUR/MINUTE**.
3. Use the **CURSOR PAD ▲, ▼** or **▼** to highlight and select **START TIME AM/PM**.
4. Use the **CURSOR PAD ►, ▲** or **▼** to highlight and select **FINISH TIME HOUR/MINUTE**.
5. Use the **CURSOR PAD ►, ▲** or **▼** to highlight and select **FINISH TIME AM/PM**.
6. Use the **CURSOR PAD ►** to highlight the **MONTH**.
7. Use the **CURSOR PAD ▲** to select a **MONTH** or **CURSOR PAD ▼** to select **DAILY, WEEKLY - SUNDAY TO MONDAY**. Use the **CURSOR PAD ◀** to return to **MONTH**.
8. Use the **CURSOR PAD ►, ▲** or **▼** to highlight and select the **DAY** of the **MONTH**.
9. Use the **CURSOR PAD ►, ▲** or **▼** to highlight and select the **YEAR**.
10. Use the **CURSOR PAD ►, ▲** or **▼** to highlight and select **CABLE** or **AIR**.
11. Use the **CURSOR PAD ►, ▲** or **▼** or **NUMBER** buttons to set the channel the TV will tune into. A in the box means it is enabled.

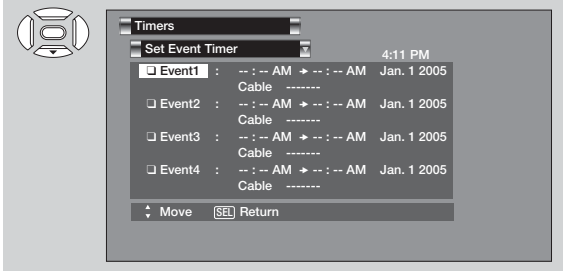
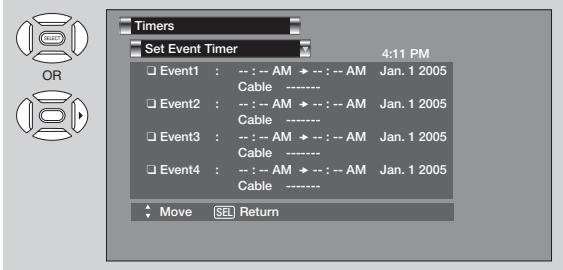
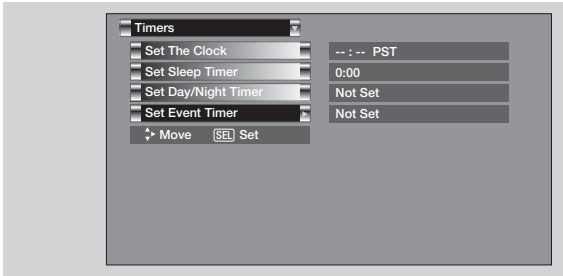

- NOTE:**
1. When the **INFO** button is pressed, the **Event Timer Icon** will only display the current date **ON/OFF** timer.
 2. The **OFF TIMER** will only activate if the TV was turned on by the **ON TIMER** and no channel selection was made after this time. If you change the channel after the **ON TIMER** has been activated, the **OFF TIMER** will deactivate.
 3. If no remote control button is pressed after viewing reservation is activated, the TV will automatically turn off after three hours. Therefore, do not **SET EVENT TIMER** for more than three hours if you do not plan to control your television with the remote control.



CAUTION: Do not use your TV as a deterrent when away from home by using the **ON** and **OFF TIMERS**. For safety, the TV should be turned off when you are away from home.

Setup

Setup

Select **SETUP** when setting your TV up for the first time.

1. Use the **CURSOR PAD** ▲, ▼, ◀ or ▶ to select the sub-menu of your choice.
2. Press the **SELECT** button to select.

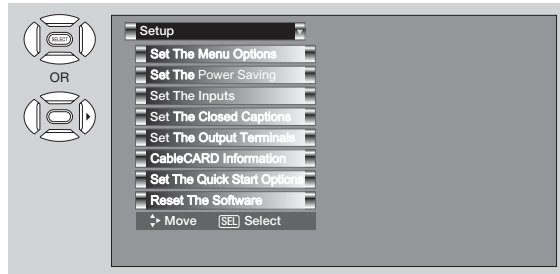
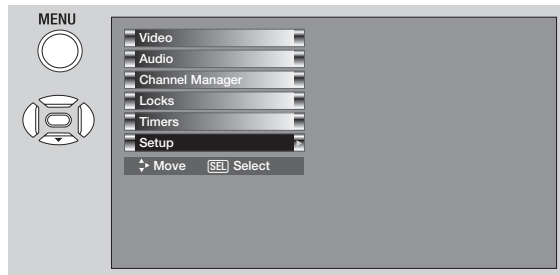

Set The Menu Options

Setup the Language and background of the Menu OSD.

Set The Language

This feature will allow you to select any one of three different languages for all on-screen displays.

1. Use the **CURSOR PAD** ◀ or ▶ to select the language of your choice.
2. Press **EXIT** to quit menu or select **SET THE MENU OPTIONS** to return to previous menu.

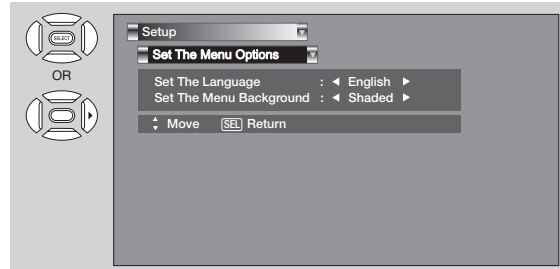
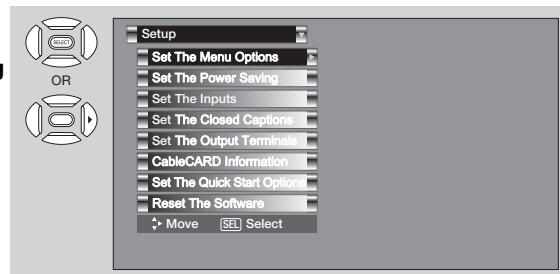

Setup

Set The Menu Background

This function allows you to choose from two menu backgrounds.

1. Use the **CURSOR PAD** ◀ or ▶ to highlight **SET THE MENU BACKGROUND (SHADED OR SOLID)** of your choice. Use the **CURSOR PAD** ◀ or ▶ to select shaded or solid.
2. Select **SOLID** for a black background (no picture can be seen behind menu screen), select **SHADED** and a light background is visible.
3. Press **EXIT** to quit menu or select **SET THE MENU OPTIONS** to return to the previous menu.

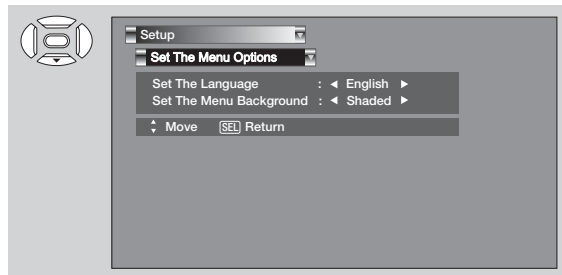

Set The Power Saving

This feature help to increase the Lamp life. Use this feature to have the TV turned OFF automatically when a video signal is not detected for 15 minutes.

1. Press the **CURSOR** buttons ◀ or ▶ to highlight Yes or No.

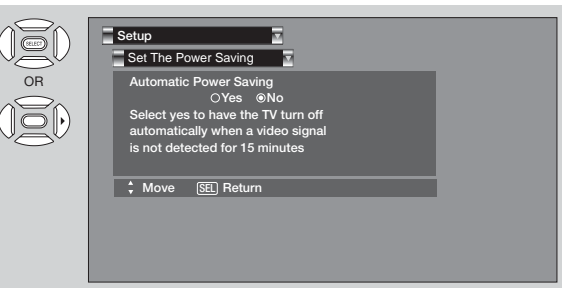
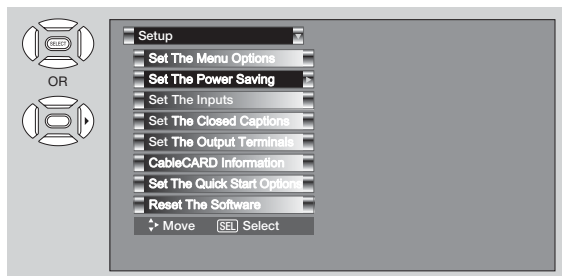

NOTE: Your new HDTV has a built-in Automatic Power Saving feature that shuts Off the TV if a video signal is not detected within 15 minutes. The default setting for this feature is ON (Yes). The Automatic Power Saving feature needs to be set to OFF (No) before any CableCARD set up can be performed.

INSTRUCTIONS:

1. Access the Menu OSD by press the MENU button of the remote control.
2. Navigate the menu to access SETUP, then SET THE POWER SAVING. SET AUTO POWER SAVING OFF (No) using the Cursor and the SELECT buttons of the remote control.
3. Use the Cursor buttons to highlight "No" then press the SELECT button to set this feature to Off.
4. After CableCARD set up is completed, set the Auto Power Saving feature to ON (Yes).

Setup

Set The Inputs

Use this feature to give a name to any of the five video inputs.

1. Press the **CURSOR PAD ▲, ▼** to highlight the video inputs.
2. Press the **CURSOR PAD ◀, ▶** to select your choices.

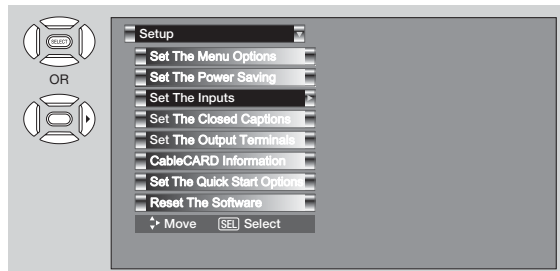

Note: The inputs labeled Gray out (Skip) or Hide (Skip) are disabled in the **INPUTS** selection.

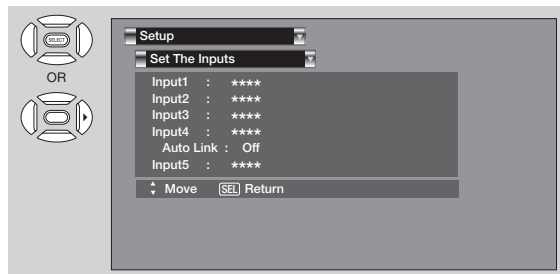

INPUT 4 Auto Link

Use this function to automatically turn the TV on and tune to INPUT 4 when it detects a video signal to INPUT 4.

1. Use the **CURSOR PAD ▲, ▼, ◀ or ▶** to highlight and select the **AUTO LINK** setting of your choice.

Auto

When **AUTO** is selected, the TV will turn on and switch to INPUT 4 automatically, when the INPUT 4 input device is turned on. This is convenient when you want to watch a movie with your VCR, laserdisc player, or DVD player.

Remote

When **REMOTE** is selected, the TV will turn on and switch to INPUT 4 automatically when the INPUT 4 input device is turned on and the VCR, laserdisc, or DVD play button on your remote control is pressed. This is convenient when you want to record a movie with your VCR and watch it later.

Off

Select **OFF** to disable this function.





2. Press **EXIT** to quit menu or select **AUTO LINK** to return to previous menu.

- NOTE:**
1. Once the TV has been turned on using the **AUTO LINK** feature, it must be reset before **AUTO LINK** is used again. To do this, turn your VCR, laserdisc, or DVD player OFF. This feature is now reset and will turn on your TV as described above.
 2. When using **REMOTE** mode, any remote control button will substitute for your video input device play button. However, intended operation is for use with your VCR, laserdisc, or DVD play button.
 3. If no remote control button is pressed after the TV is turned on by **AUTO LINK**, the TV will automatically turn off after three hours.

Setup

Set The Closed Captions

Closed Captions are the dialogue, narration, and/or sound effects of a television program or home video which are displayed on the TV screen. Your local TV program guide denotes these programs as **CC** or .

1. Use the **CURSOR PAD** , ,  and  to highlight and select the function to change.
2. Press **EXIT** to quit menu or select **SET THE CLOSED CAPTIONS** to return to the previous menu.

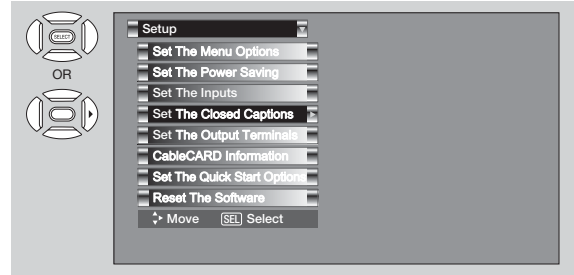

Caption Display:

ON/OFF will turn the **CC** display on or off.
AUTO will turn the **CC** display on when Mute/Soft Mute is on.

Analog Captions:

Set **CAPTIONS** for Analog programs. This function will help choose and set available mode and channel.



Caption Mode:

CAPTIONS is for the program you are viewing.





TEXT is for additional information such as news reports or a TV program guide. This information covers the entire screen and viewing the TV program is not possible. Text may not be available with every **CC** program.

Channel:

- 1 is used for the primary language (usually English).
- 2 is sometimes used for a second language (may vary by region).
- 3 is sometimes used for a third language (may vary by region).
- 4 is sometimes used for a fourth language (may vary by region).

Digital Captions

Set captions for digital programs. This function will help choose and set available language, font, size and style of digital captions.

1. Use the **CURSOR PAD** , ,  or  to highlight and select desired **DIGITAL CAPTIONS** feature.
2. Press **EXIT** to quit menu or select **SET CLOSED CAPTION** to return to the previous menu.

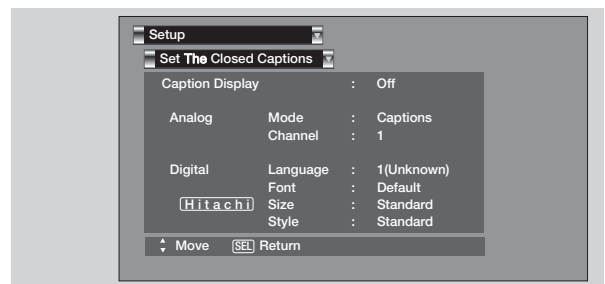

- NOTE:**
1. Some types of digital closed captions will not work with this TV.
 2. Caption Display will not work when viewing a 480p, 720p, or 1080i input via the **COMPONENT: Y-PbPr** inputs.
 3. Digital Captions Font Style are sometimes different from the Font Style of Analog Captions.
 4. Closed Caption and Digital Captions availability and content depends on the broadcaster. Closed Caption is available when Closed Caption icon is displayed on screen.
 5. Digital Captions will not be available (grayed out) when using analog channels.

Setup

Set The Output Terminals

This feature will select the source of the Output Terminal.

Video Out :

- Select **MONITOR** to output the audio and video signals of the chosen input source (**CABLE/AIR or INPUT 1-5**) to a VCR or other A/V device.
- Select **TV TUNER OUT** to output the audio and video signals of the last watched Antenna Source (**CABLE/AIR**).

Audio Out:

- Select **AUDIO OUT FIXED** to have the Audio at fixed volume.
- Select **AUDIO OUT VARIABLE** to have Audio volume that can be controlled by the TV Volume Up/Down.

Video Out	Audio Out	Use
Monitor	Fixed	To record currently viewed Video and Audio.
Monitor	Variable	When an external device like a monitor or Hi-Fi audio system is connected to the audio and video output of the TV. You can control the volume output by changing the volume of the TV.
TV Tuner Out	Fixed	To record currently viewed Video and Audio from either Cable or Air.

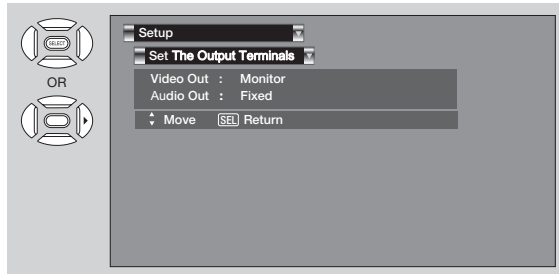
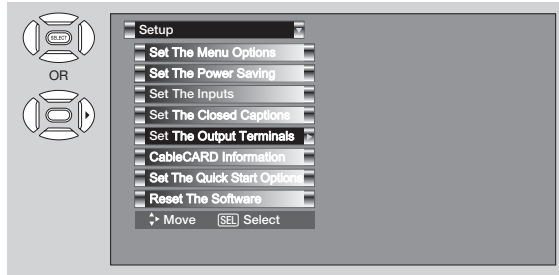

1. Use **CURSOR PAD ▲** or **▼** to highlight the function to change
2. Use the **CURSOR PAD ◀** or **▶** to select the function.
3. Press **EXIT** to quit menu or select **SET THE OUTPUT TERMINALS** to return to previous menu.

NOTE: 1. When **TV TUNER OUT** is selected, **VARIABLE AUDIO OUT** will not be available (grayed out).
2. When using **MONITOR OUT** for recording, set the **VIDEO OUT** to **MONITOR**.

MONITOR: Available Monitor Out Signals

TV TUNER OUT: Available Monitor Out Signals

Input Mode				Monitor Out			
ANT (Air or Cable)	Digital Channel	No Macrovision	S-Video	S-Video	L/R	HiFi	
			Macrovision	S-Video	Video	YES	YES
Input 1	HDMI_1		-	-	-	YES	
	S-Video_1		YES	YES	YES	YES	
	Video_1		-	YES	YES	YES	
Input 2	HDMI_2		-	-	-	YES	
	S-Video_2		YES	YES	YES	YES	
	Video_2		-	YES	YES	YES	
Input 3	Y-PbPr_3		-	-	-	YES	
	Video_3		-	YES	YES	YES	
Input 4	Y-PbPr_4		-	-	-	YES	
	Video_4		-	YES	YES	YES	
Input 5	Y-PbPr_5		-	-	-	YES	
	Video_5		-	YES	YES	YES	

Input Mode				Monitor Out (TV Tuner Out)			
ANT (Air or Cable)	Digital Channel	No Macrovision	S-Video	S-Video	L/R	HiFi	
			Macrovision	S-Video	Video	YES	YES
Input 1	HDMI_1		YES	YES	YES	YES	
	S-Video_1		YES	YES	YES	YES	
	Video_1		-	YES	YES	YES	
Input 2	HDMI_2		YES	YES	YES	YES	
	S-Video_2		YES	YES	YES	YES	
	Video_2		-	YES	YES	YES	
Input 3	Y-PbPr_3		YES	YES	YES	YES	
	Video_3		ANT digital only	ANT digital only	ANT digital only	ANT digital only	
	Video_3		-	YES	YES	YES	
Input 4	Y-PbPr_4		YES	YES	YES	YES	
	Video_4		-	YES	YES	YES	
Input 5	Y-PbPr_5		YES	YES	YES	YES	
	Video_5		-	YES	YES	YES	

Setup

CableCARD Information

After the CableCARD has been successfully installed, you can access CableCARD Information menu in the SETUP menu of the On-Screen Display.

Follow the instructions below to access the CableCARD Information menu.

1. Press the **MENU** button on the Remote Control to access the Main Menu screen.
2. Use the **CURSOR PAD ▼** to highlight **SETUP** in the Main Menu and press the **SELECT** button.
3. Use the **CURSOR PAD ▼** to highlight **CableCARD Information** and press the **SELECT** button.
4. To view the CableCARD ID and Host ID, use the **CURSOR PAD ▼** to highlight **CableCARD Info** and press the **SELECT** button.

NOTE: The **Diagnostics Info.** window is for Service use only.

THINGS TO CHECK WHEN USING THE CableCARD / CableCARD Services

1. Check that the CableCARD is properly inserted in the CableCARD slot.
2. Remove the CableCARD by pressing and pulling the CableCARD straight out.
3. Visually inspect the CableCARD to ensure all pin-holes are in good condition, with none blocked or damaged.
4. Make sure the CableCARD is re-inserted in the correct direction, then slowly push until it is fully seated in the slot.
5. When the CableCARD is installed, note all screen messages that appear ("CableCARD Installed", "Acquiring Data", "CableCARD is not Installed"). If the "CableCARD Installed" message does not appear when card is installed, check the TV's card slot and CableCARD pins for obstructions or damage.
6. If problems still remain, please contact your Cable Service Provider.

NOTES:

1. When a CableCARD is installed, Auto Channel scan will not be needed because the channel list is automatically loaded to the TV's channel memory.
2. The TV will take several seconds to detect and recognize the presence of the CableCARD. This process must be completed before any CableCARD information or Channel listings is accessed.

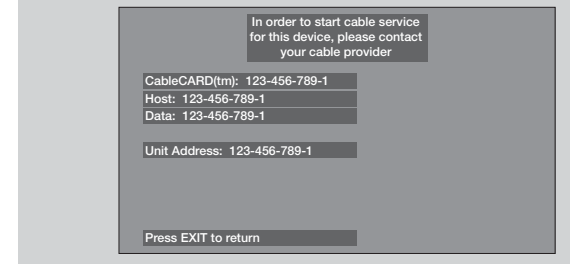
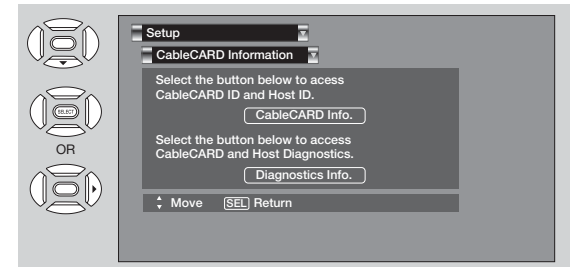
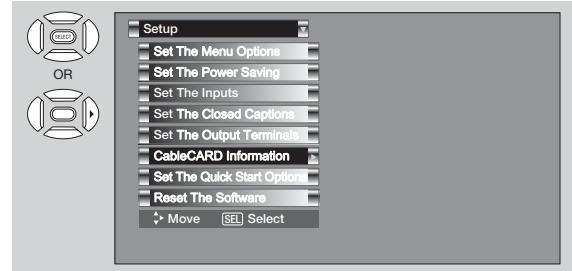
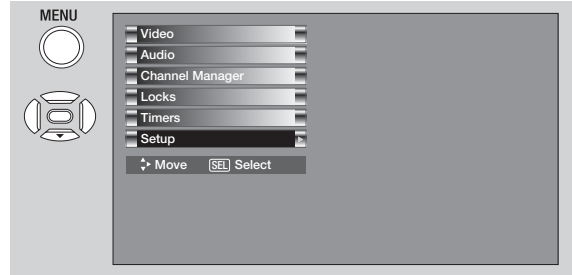

Setup

Set The Quick Start Options

This feature will select **QUICK START UP** options. Set this feature to **ON** to have the TV tune channels (both Analog and Digital) quickly when first turning the TV on. Set this feature to **OFF** to save electricity. Selecting **ON** for the **QUICK START UP** feature will activate the TV tuners circuits when the TV is in "standby mode" which is commonly referred to as "off". This will allow you to quickly tune to channels when first turning the TV on. Digital signals often change and this feature will monitor any changes and prepare the television to quickly present a picture. A small amount of electricity is used to continually monitor signals when this feature is selected.

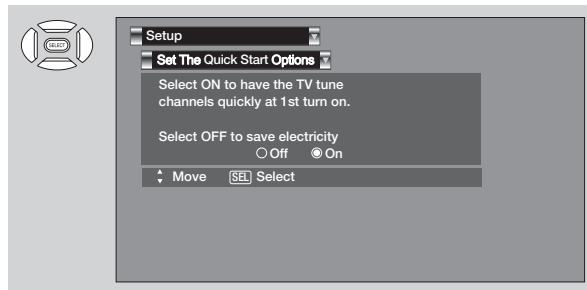
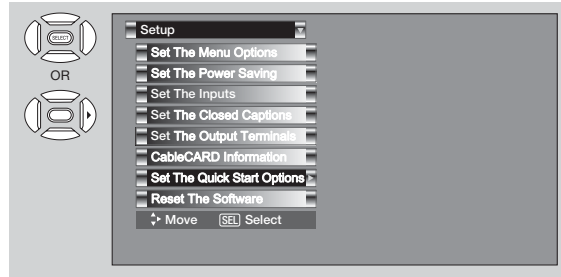

Reset The Software

This feature shows software information and easy upgrade procedure. This function allows the TV software to be upgraded by using a flash card (**MMC CARD**). If a future software upgrade is required for your TV, **HITACHI** will notify and provide you with a flash card. In order to receive written notification and the flash card, please complete and return the warranty card.

1. Insert **MMC CARD**
2. Press the **CURSOR PAD ▲** or **▼** to highlight **UPGRADE NOW**.
3. Press the **SELECT** button to select and start upgrading.
4. Unplug the AC power cord or press the **POWER** button in the Front panel for 5 sec. when the **UPGRADE** is complete.

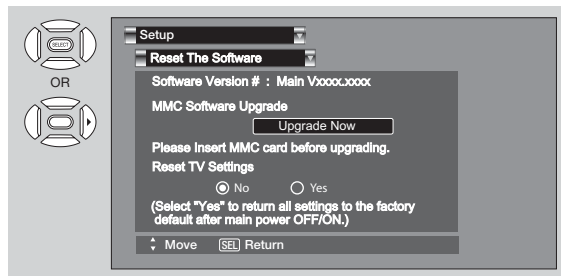
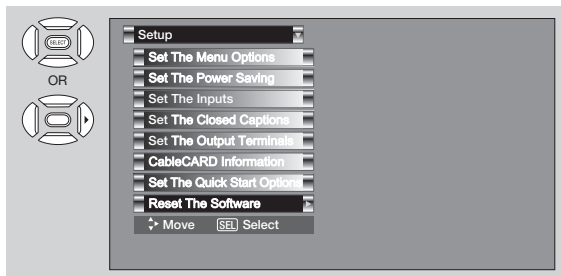

NOTE: Any power interruption during the upgrade process will cancel the upgrade. When this happens, repeat the upgrade procedure.

Reset TV Settings

This function allows you to Reset all TV Settings to the original factory settings on all modes during the next power on/off.

1. Use **CURSOR PAD ▲, ▼** to highlight functions.
2. Press the **SELECT** button or **CURSOR PAD ►** to select **Reset The Software**.
3. Use the **CURSOR PAD ▼** to access at the **Reset softkey**.
4. Press the **SELECT** button to **Reset the TV Settings** and unplug the AC power cord or press the **POWER** button in the front panel for 5 sec.

NOTE: If **YES** is selected, **ALL TV MENU SETTINGS** will be reset to the original factory settings on all modes during the next power on/off.

Lamp Replacement

Lamp Life

The lamp life may vary based on usage of the LCD Rear PTV. Turning on and off frequently may shorten the life of the lamp.

Lamp Replacement

After extended use, if the TV picture turns dark, the color looks unusual or LAMP INDICATOR light turns on, then it is time to replace the lamp with a new lamp.

WARNING:

The lamp gets very hot! The lamp may explode if improperly handled. To avoid injury, please observe the following precautions.

- *Do not open lamp compartment or attempt to remove lamp assembly unless the lamp assembly is being replaced.*
- *Unplug the product's power cord from the AC outlet before attempting to replace the lamp assembly.*
- *If the lamp is in use when failure occurs or if the lamp has exploded, wait at least 30-45 minutes for the lamp to cool before opening the lamp compartment or touching the lamp assembly or any broken pieces.*
- *Broken lamp pieces can cause injury. Handle with gloves to avoid cuts.*
- *Do not place any foreign objects inside the lamp compartment.*
- *When installing a new lamp, follow handling instruction included with the new lamp. Do not touch glass surface of new lamp.*
- *(Hg) This product contains lead and a lamp that contains mercury. Dispose of this product and its lamp in accordance with applicable environmental laws. For lamp recycling and disposal information, go to www.lamprecycle.org. For product recycling and disposal information, contact your local government agency or eRecycle.org (in California), the Electronic Industries Alliance at www.eiae.org (in the US) or the Electronic Product Stewardship Canada at www.epsc.ca (in Canada). For more information, call "1-800-HITACHI."*

CAUTION!

A "LAMP" indicator will light when lamp becomes hot. Unplug product's power cord from the AC outlet and allow lamp to cool for at least 30-45 minutes. If "LAMP" indicator is still lit, please contact your authorized service center (see page 63).

NOTES:

- *Contact your Hitachi dealer for a new lamp unit. Using other lamps may cause damage to the TV Set.*

<u>MODEL#</u>	<u>LAMP TYPE</u>	<u>PART#</u>
50VS69A	LP600	UX25951
55VS69A	LP600	UX25951
62VS69A	LP600	UX25951

- *When replacing the lamp, let it cool down completely, for approximately 30 to 45 minutes after the power has been switched off and A.C. cord has been unplugged.*
- *Do not touch the glass of the new lamp or make it dirty which can shorten the life of the lamp and reduce the picture quality.*
- *Keep the lamp out of the reach of children and away from flammable materials.*
- *Do not pour water onto the removed lamp or put any object inside the lamp.*
- *Once the lamp is removed, do not put flammable materials and metal objects inside the lamp receptacle on the TV set. Do not touch the receptacle.*
- *Install the new lamp securely, otherwise the picture may become dark or it may cause severe overheating.*
- *Install the lamp cover correctly, otherwise power will not come on.*

Lamp Replacement

Lamp Replacement

1. Turn off the TV and unplug the power cord. Wait at least 30 minutes to allow the lamp to cool down before replacing it.

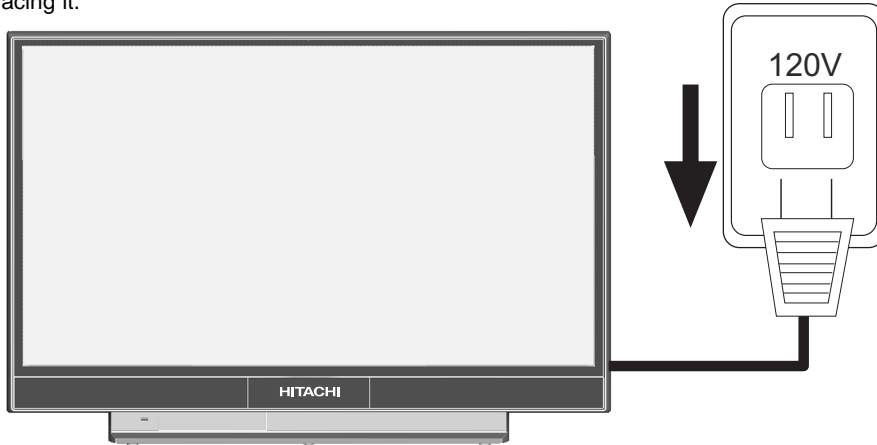

CAUTION: The lamp is very hot and may cause fire or severe burns. Wait at least 30~45 minutes to allow the lamp to cool before proceeding with lamp removal.

2. At the rear of the TV, locate the LAMP COMPARTMENT. Using a Phillips type screwdriver loosen the screw until the LAMP COVER can be removed.

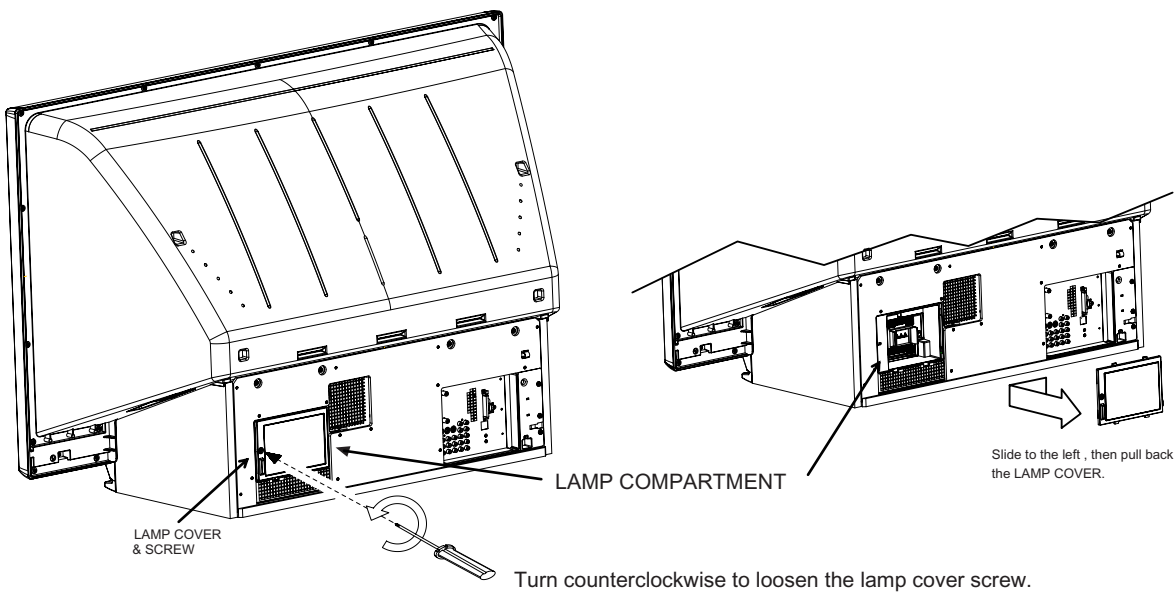

NOTE:  This product contains lead and a lamp that contains mercury. Dispose of this product and its lamp in accordance with applicable environmental laws. For lamp recycling and disposal information, go to www.lamprecycle.org. For product recycling and disposal information, contact your local government agency or the Electronic Industries Alliance at www.eiae.org (in the US) or the Electronic Product Stewardship Canada at www.epsc.ca (in Canada). For more information, call "1-800-HITACHI."

Lamp Replacement

- Loosen the screw securing the lamp unit with a Phillips head screw driver as shown. Remove the lamp unit by holding the lamp handle, then pulling outwards.

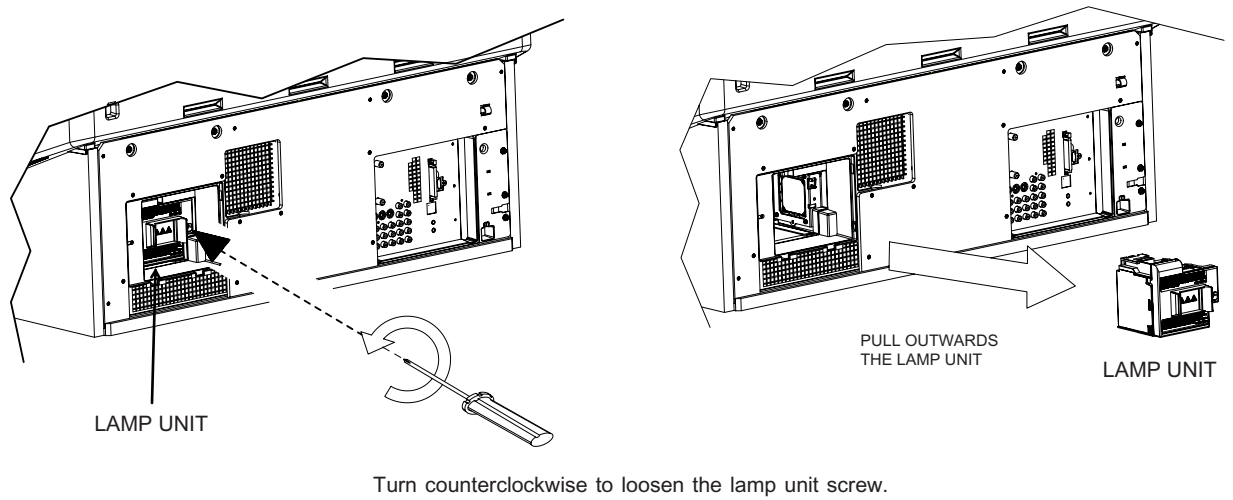

CAUTION: The lamp is very hot and may cause fire or severe burns. Wait at least 30–45 minutes to allow the lamp to cool before proceeding with lamp removal.

NOTE: Do not put your hand in the Lamp Storage area after the Lamp Unit is removed, you may get burned.

- Replace with the new lamp.
Place the removed lamp into the empty box of the replacement lamp. Do not touch the front glass of the new lamp or its receptacle. This may shorten the life of the lamp and reduce the picture quality.
 - Push the lamp unit back to its original position.
 - Tighten the screw firmly on the lamp unit. If it is loose, the TV may not operate correctly.

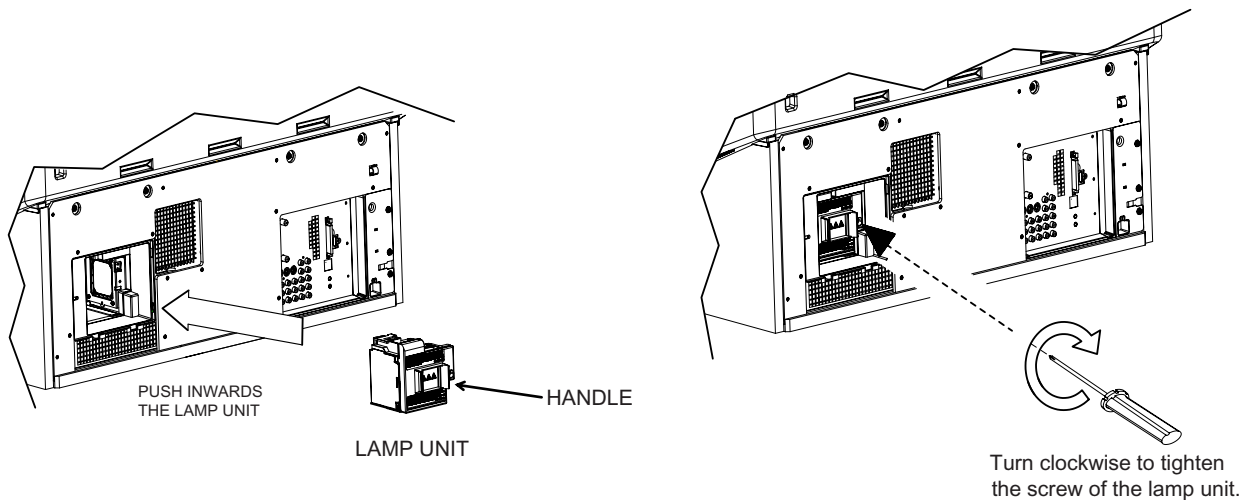

Lamp Replacement

5. Be sure to install the lamp cover by re-engaging the two clips and slide to the right. Then tighten the screw of the lamp cover before turning the power on, otherwise it may cause unusual colors. If the lamp cover is not installed and you try to turn ON the TV, the power will be off and the Lamp Indicator will flash (see page 9).

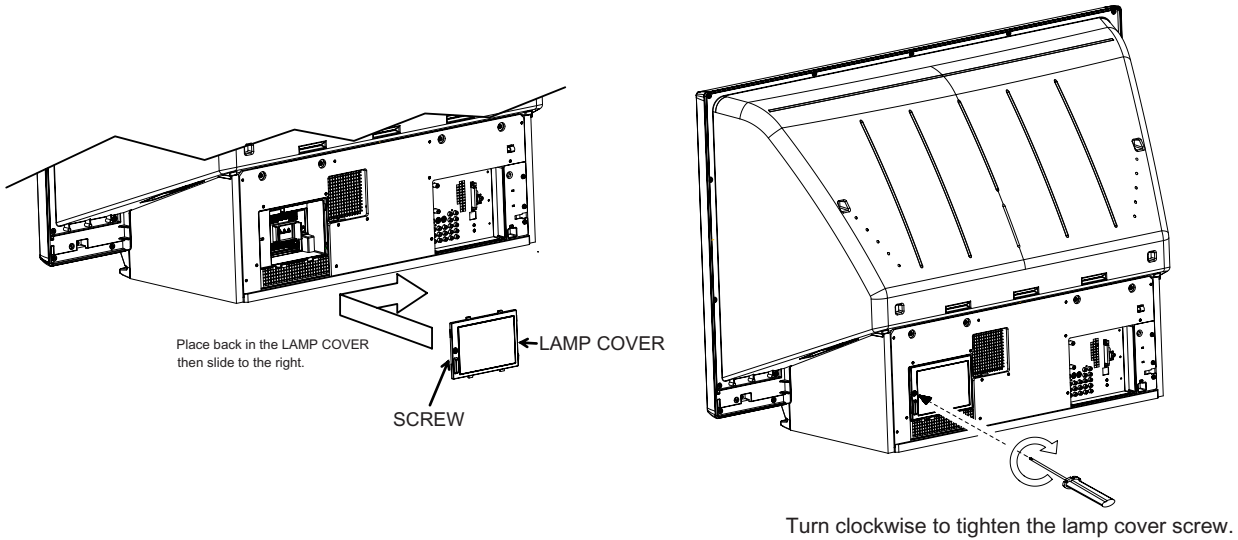

NOTE: If power is connected before the Lamp Cover is installed, the power will be off and the Lamp Indicator will flash (see page 9).

6. Plug power cord into AC outlet and turn on the main power switch.

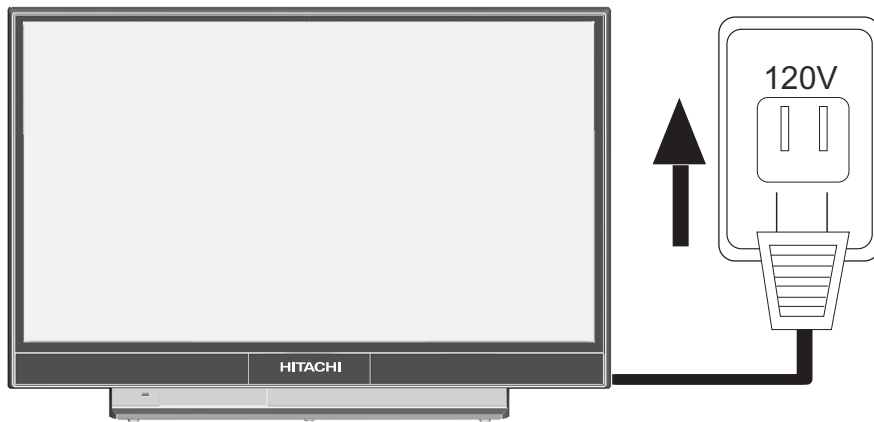

NOTE:  This product contains lead and a lamp that contains mercury. Dispose of this product and its lamp in accordance with applicable environmental laws. For lamp recycling and disposal information, go to www.lamprecycle.org. For product recycling and disposal information, contact your local government agency or eRecycle.org (in California), the Electronic Industries Alliance at www.eiae.org (in the US) or Electronic Product Stewardship Canada at www.epsc.ca (in Canada). For more information, call "1-800-Hitachi".

Equipment Care and Troubleshooting

DO

- Dust the screen and cabinet with a soft cloth.
- Clean the screen with a soft cloth moistened in warm water and dry with a soft cloth. A mild soap may be used if the screen is extremely dirty.
- Place your Television away from extreme heat, humidity, and extremely dusty places.
- Remove the plug from the wall outlet if your Television will not be used for a long period of time, for instances, when you go on vacation.

DO NOT

- Do not clean your screen or cabinet with strong cleaners, polishes or a chemically treated cloth.
- Do not place rubber or vinyl products or cellophane tape on your Television.
- Do not touch the screen too often.
- Do not subject the remote control to shocks such as dropping it on the floor, etc. Physical damage to the precision parts may result.
- Avoid placing the remote control in a high humidity place or getting it wet. Do not leave it on or near a heater. Excessive heat or moisture may cause the unit to cease operation.
- When the batteries run down, remote control operation will become erratic or possibly stop altogether. Replace the old batteries with two new "AA" size batteries as soon as possible to preserve the remote control precodes that were set for the devices. Pressing a remote control button with a "DEAD" battery might erase all precodes in memory. Do not use an old battery with a new battery.
- Exposure of the viewing screen to prolonged direct sunlight or heat may cause the screen to permanently warp, resulting in a distorted picture..

TROUBLESHOOTING

HITACHI LCD Rear Projection Television incorporates advanced power surge protection technology designed to protect against component or circuit damage due to external or internal voltage power surges.

IF YOUR TELEVISION SHOULD APPEAR TO HAVE A LOSS OF POWER, PLEASE FOLLOW THIS PROCEDURE:

1. Press the **POWER SWITCH (ON/OFF SWITCH)** once.
2. If there is still no power, wait 30 seconds and press the **POWER SWITCH** again.
3. If there is still no power, unplug the power cord from the wall. Wait 30 seconds and plug the power cord back in. Press the **POWER SWITCH** again.

This protective technology should provide for years of lasting entertainment from your **HITACHI** LCD Rear Projection Television.

SYMPTOMS	CHECK THESE ITEMS AND TRY THESE ADJUSTMENTS											
	Be sure external connection is correct	Be sure power cord is plugged in	Be sure TV is switched "ON"	Try another channel (station trouble)	Check antenna connections (back of TV)	Check antenna for broken lead-in wire	Check for local interference	Adjust Contrast control	Adjust Brightness control	Adjust Color control	Adjust Trim control	Adjust Volume control
No Picture, no sound	●	●	●	●	●	●						
Sound OK, picture poor	●			●	●	●	●	●	●			
Picture OK, sound poor	●			●	●	●	●					●
Picture blurred	●			●	●	●	●					
Lines or streaks in picture				●	●	●	●					
Poor reception on some channels				●	●	●	●					
Picture rolls vertically				●				●				
No color	●			●	●	●	●			●		
Poor color	●			●	●	●	●			●	●	

Reception Problems

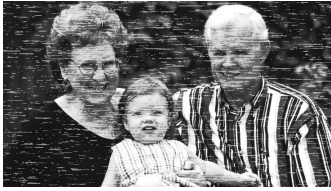

IGNITION NOISE:

Black spots or horizontal streaks may appear, picture may flutter or drift. Usually caused by interference from automobile ignition systems, neon lamps, electrical drills, and other electrical appliances.



GHOSTS:

Ghosts are caused by the television signal following two paths. One is the direct path and the other is reflected from tall buildings, hills or some other objects. Changing the direction or position of the antenna may improve reception. Ghosting may also be caused by defects in the antenna system such as unshielded leads or connecting several sets to the same antenna without using multiple antenna couplers.



SNOW:

If your receiver is located in the fringe area of a television station where the signal is weak, your picture may be marred by the appearance of small dots. When the signal is extremely weak, it may be necessary to install a special antenna to improve the picture.

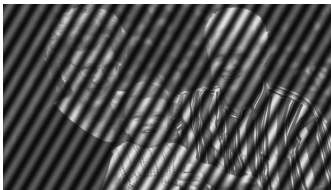

RADIO FREQUENCY INTERFERENCE:

The interference produces moving ripples or diagonal streaks, and in some cases, causes loss of contrast in the picture.



BLOCK NOISE (DIGITAL INPUT):

Fuzzy blocks may appear in some area or the whole area of the screen. This is usually caused by interference from automobile ignition systems, neon lamps, electrical drills, ghosting of the image and weak signals.

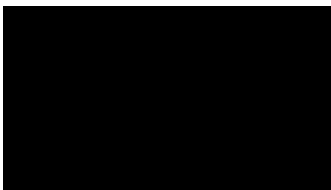

BLACK SCREEN:

When using an antenna, weak signals will display a black screen. It may be necessary to upgrade your antenna.

NOTE: The TV set can generate sound distortion in external devices such as a radio. Please separate radio equipment from the TV set to a considerable distance.

AGENCY REGULATORY INFORMATION

Federal Communications Commission Notice

This equipment has been tested and found to comply with the limits for a Class B digital device, pursuant to Part 15 of the FCC Rules. These limits are designed to provide reasonable protection against harmful interference in a residential installation. This equipment generates, uses and can radiate radio frequency energy and if not installed and used in accordance with the instructions, may cause harmful interference to radio communications. However, there is no guarantee that interference will not occur in a particular installation. If this equipment does cause harmful interference to radio or television reception, which can be determined by turning the equipment off and on, the user is encouraged to try to correct the interference by one or more of the following measures:

- Reorient or relocate the receiving antenna.
- Increase the separation between the equipment and the receiver.
- Connect the equipment into an outlet on a circuit different from that to which the receiver is connected.
- Consult the dealer or an experienced radio/television technician for help.

FCC Information

This device complies with part 15 of the FCC Rules. Operation is subject to the following two conditions :
(1) This device may not cause harmful interference and (2) This device must accept any interference received, including interference that may cause undesired operation.

Modifications



The FCC requires the user to be notified that any changes or modifications made to this device that are not expressly approved by Hitachi America ,Ltd. Home Electronics Division may void the user's authority to operate the equipment.

Cables

Connections to this device must be made with shielded cables with metallic RFI/EMI connector hoods to maintain compliance with FCC Rules and Regulations.

Any cables that are supplied with the system must be replaced with identical cables in order to assure compliance with FCC rules. Order Hitachi spares as replacement cables.

Note

This LCD Rear Projection Television receiver will display television closed captioning, ( or ), in accordance with paragraph 15.119 and 15.122 of the FCC rules.

INDUSTRY CANADA AGENCY REGULATORY INFORMATION

Cable Compatible Television Apparatus- Télévision câblocompatible, Canada.

Features and Specifications

Features:

- New Easy-to-Use On-Screen Menu Control (3 Language)
- Downloadable V-Chip
- Preprogrammed Remote Control
- Power Management: ON/OFF via signal detection
- Picture Enhancement
- Input Signal Identification
- CableCARD compatible - Contact your local cable operator for more information
- HDMI (High Definition Multimedia Interface)(High Bandwidth Digital Content Protection V1.1 Compatible)
-  Technology

Video:

- Superfine Picture Quality; 1280 Line Horizontal Resolution
- Video Input Sensor
- 3 Color Temperature Presets: High, Standard, Medium.
- Multiple Screen Fill Modes (4:3 Standard/Expanded/Zoom1/Zoom2/16:9 Standard/Zoom)¹
- 4MB 10-bit 3D Y/C Comb Filter
- Picture Modes (Day-Normal, Day-Dynamic and Night)

Inputs:

- Power Input AC 120V, 60Hz
- Power Consumption
- Refer to rear panel at the back of the TV set
Stand-by Power .. Less than 1 Watt
- Antenna input impedance 75 Ohm
- Channel coverage 191ch.
VHF-Band 2 ~ 13
UHF-Band 14 ~ 69
CATV Mid Band A-5 ~ A-1
..... A-I
Super Band J-W
Hyper Band W+1 - W+28
Ultra Band W+29 - W+94
- Television System NTSC Standard
ATSC Standard (8 VSB, 64-QAM, 256-QAM)
- Video 1.0Vp-p, 75 Ohm
- S-Video
Luminance (Y) 1.0Vp-p, 75 Ohm
Chrominance (C) 0.286Vp-p, 75 Ohm
- Component Video
Luminance (Y) 1.0Vp-p, 75 Ohm
Chrominance (P_B/P_R) 0.7Vp-p, 75 Ohm
- Audio input Impedance 270k Ohm
- Average input level 470mVrms
- HDMI (19 PIN)

Outputs:

- Video 1.0Vp-p, 75 Ohm
- Audio 470mVrms, 1k Ohm
- Optical Out (Digital Audio) 1 Optical Connector

Audio:

- MTS Stereo/SAP
- Bass Boost
- Surround Sound
- 24W
- Soft Mute (50%)

Supplied Accessories:

- Remote Control
- Batteries

Optional Accessories:

- For U.S. Models: Please access our website: www.hitachi.us/tv

INPUTS/OUTPUTS

• Wideband Component Y, Pb,Pr	3
• Composite Video	5
• SVideo	2
• Antenna (RF) Input	1
• Audio Output	1
• Monitor Output	1
• Optical Output	1
• CableCARD Slot	1
• Upgrade Card Slot	1
• HDMI	2

DIMENSIONS:

	50VS69A	55VS69A	62VS69A
Height (in.)	31 15/16	34 13/16	38 13/16
(mm)	812.0	884.0	985.0
Width (in.)	46 5/16	50 11/16	56 13/16
(mm)	1,177.0	1,288.0	1443.0
Depth (in.)	17 5/16	17 11/16	19 1/2
(mm)	439.0	449.0	495.0
Weight (lbs.)	79	86	104
(kg.)	36	39	47

NOTE: Due to improvements, specifications in this operating guide are subject to change without notice.

¹ Screen mode availability varies by input format

HDTV Televisions display HDTV only when an HDTV source is available.

All specifications, weights, and dimensions are subject to change without prior notice. Please access www.hitachi.com/tv for detailed specifications and dimensions for custom installations.

UltraVision Digital is a registered trademark of Hitachi Home Electronics (America), Inc.



COPYRIGHT © 1999-2006 MONTAVISTA SOFTWARE, INC. ALL RIGHTS RESERVED.

HDMI™ HDMI, the HDMI logo and High-Definition Multimedia Interface are trademarks or registered trademarks of HDMI Licensing LLC.

*Manufactured under license from Dolby Laboratories. "Dolby" and the double-D symbol are trademarks of Dolby Laboratories.

HITACHI

Inspire the Next

Service Hotline

To locate an authorized **HITACHI** service facility in the continental U.S.A. and Canada,

DIAL TOLL FREE

7 days a week, 24 hours a day

1-800-HITACHI

(1-800-448-2244)

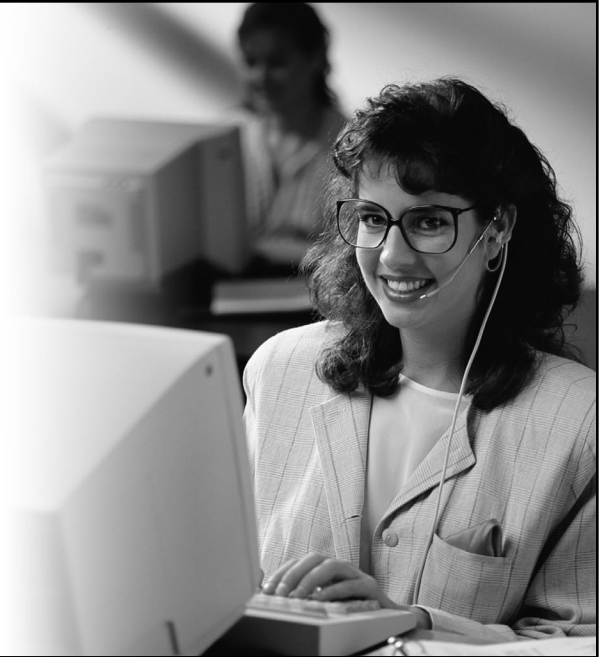

HITACHI AMERICA, LTD.
HOME ELECTRONICS DIVISION

HITACHI has made every effort to assure you hours of trouble free operation from your unit. However, should you require service, a network of HITACHI Authorized Service Facilities has been established in all 50 states and Puerto Rico. Each facility will provide you with convenient and expedient assistance. Our service hotline operator will direct you to the HITACHI Authorized Service Facility nearest you. Just present proof of purchase and/or delivery receipts to the Hitachi Authorized Service Facility, and service will be rendered in accordance with the terms of the limited warranty as stated on your warranty card or operating guide.

Should you have any questions regarding warranty, service, operation, or technical assistance, please contact:

Hitachi America, LTD.
Home Electronics Division
900 Hitachi Way
Chula Vista, CA 91914-3556

HITACHI CANADA, LTD.
DIGITAL MEDIA DIVISION

Should you have any questions regarding warranty, service, operation, or technical assistance, please contact:

In Canada: 1-800-HITACHI (1-800-448-2244)

Monday – Friday (EST).....9:00am – 7:00pm
Saturday (EST)9:00am – 5:00pm

Look for your French Manual on the outside of the box. If the manual is missing, call **1-800-HITACHI (1-800-448-2244)** for a copy.

Pour de plus amples renseignements sur le service durant la période couverte par la garantie, sur le fonctionnement ou pour de l'assistance technique communiquez avec:

Au Canada: 1-800-HITACHI (1-800-448-2244)

Lundi - Vendredi L'EST9:00am – 7:00pm
Samedi L'EST.....9:00am – 5:00pm

La version français de votre manuel se trouve a l'exterieur de la boîte. Si le manuel est manquant, coposez le **1-800-HITACHI (1-800-448-2244)** pour obenir votre copie.

HITACHI CANADA, LTD.
2495 Meadowpine Blvd.
Mississauga, Ontario L5N 6C3

End User License Agreement for HITACHI DTV Software

END USER LICENSE AGREEMENT FOR HITACHI DTV SOFTWARE

IMPORTANT – READ CAREFULLY: This End User License Agreement for **HITACHI** DTV Software (this "Agreement") is a legal agreement between you ("you" or "your"), in your capacity as the owner of a **HITACHI** brand digital television (the "DTV"), and **HITACHI** America, Ltd., Ubiquitous Platform System Division ("**HITACHI**"). By using the DTV or the digital television software installed on the DTV (the "DTV Software") or any Upgrade (as defined below, and together with the DTV Software, the "Software"), you agree to be bound by the terms and conditions of this Agreement. **IF YOU DO NOT AGREE TO BE BOUND BY THIS LICENSE AGREEMENT, DO NOT USE THE DTV OR THE DTV SOFTWARE.**

1. **LICENSE GRANT.** **HITACHI** grants to you, for the life of the DTV, a non-exclusive, non-transferable, revocable license to install and use one copy of the Software on the DTV, subject to the following limitations and restrictions:
 - a. You may not share, duplicate, republish or redistribute the Software;
 - b. You may not resell, rent, lease, sublicense, gift, loan, assign or otherwise transfer the Software or any of your rights under this Agreement;
 - c. You may not modify, adapt, translate, reverse engineer, decompile, disassemble or make derivative works from the Software or use the Software in combination with any non-**Hitachi** software; and
 - d. You may not use the Software for any commercial purpose.
2. **VIOLATIONS; INDEMNITY.** You understand and agree that your use of the Software in any manner except as permitted under this Agreement could constitute a serious crime and could subject you to damages and an award to **HITACHI** of attorneys' fees in connection with your violation of this Agreement. You further understand that you may be held legally responsible for any copyright infringement or other violation of intellectual property rights caused or facilitated by your failure to abide by the terms of this Agreement. You agree to defend, indemnify and hold **HITACHI** and its parent and affiliate companies harmless from and against any and all liability resulting from any breach by you of this Agreement.
3. **INTELLECTUAL PROPERTY.** The Software is protected by federal copyright laws, international copyright treaties and other intellectual property laws and treaties. The Software is licensed, not sold, to you. All right, title and interest in and to the Software and any intellectual property associated therewith, including any accompanying printed materials, shall belong to **HITACHI** and its licensors and suppliers. Except as expressly provided herein, neither **HITACHI** nor any of its licensors or suppliers grants to you under this Agreement any express or implied right in or to any patents, copyrights, trademarks, trade secrets or other intellectual property. All right, title and interest in and to the intellectual property rights associated with any content that is accessible through use of the Software shall belong to the applicable content owners and may be protected by copyright or other intellectual property laws and treaties. This Agreement grants you no rights to use such content. Any rights of **HITACHI** not expressly granted to you hereunder are reserved expressly by Hitachi.
4. **SOFTWARE UPGRADES.** In the future, **HITACHI** may release or make available one or more upgrades to the DTV Software (each, an "Upgrade"). You understand and agree that if you decide to install or use any Upgrade, your installation and use of such Upgrade and/or any other software or intellectual property **HITACHI** may provide in connection therewith shall be governed by the terms and conditions of this Agreement, except to the extent that **HITACHI** provides different or supplementary license terms or conditions that accompany such Upgrade or other software or intellectual property. In the event **HITACHI** provides you with a "flash card" or other media to effect or facilitate an Upgrade, you understand and acknowledge that your failure to return such flash card or other media to **HITACHI** as **HITACHI** may require could result in **HITACHI** placing your name and your DTV's serial number on a "No Further Upgrades" list, which will prohibit you from receiving any subsequent Upgrades **HITACHI** may later release or make available. **IF YOU DO NOT AGREE WITH ALL THE TERMS AND CONDITIONS OF THIS AGREEMENT OR ALL THE TERMS AND CONDITIONS OF ANY DIFFERENT OR SUPPLEMENTARY LICENSE THAT MAY ACCOMPANY SUCH UPGRADE, (A) DO NOT USE ANY HITACHI-PROVIDED FLASH CARD OR OTHER MEDIA, (B) DO NOT INSTALL ANY HITACHI-PROVIDED UPGRADE SOFTWARE ON YOUR DTV, AND (C) PROMPTLY RETURN SUCH FLASH CARD OR OTHER MEDIA TO HITACHI.**
5. **EXPORT RESTRICTIONS.** **HITACHI** is licensing the Software for use within North America only. You agree that you will not export or re-export the Software. You specifically agree not to export or re-export the Software: (i) to any country to which the U.S. has embargoed or restricted the export of goods or services, which currently include, but are not necessarily limited to Cuba, Iran, Libya, North Korea, Sudan and Syria, or to any national of any such country, wherever located, who intends to transmit or transport the Software back to such country; (ii) to any person or entity who you know or have reason to know will utilize the Software in the design, development, or production of nuclear, chemical, or biological weapons; or (iii) to any person or entity who has been prohibited from participating in U.S. export transactions by any federal agency of the U.S. government. You warrant and represent that neither the U.S. Bureau of Industry and Security nor any other U.S. federal Agency has suspended, revoked, or denied your export privileges.
6. **NO WARRANTIES.** The software is provided to you in "as is" condition and **HITACHI** makes no warranties of any kind whatsoever regarding the software and, to the maximum extent permitted by law, hereby expressly disclaims all warranties of any kind whatsoever, express or implied, with respect to the software. All implied warranties, including without limitation, the implied warranties of non-infringement, merchantability and fitness for a particular purpose are hereby expressly disclaimed by **hitachi** to the maximum extent permitted by law.
7. **LIMITATION OF LIABILITY.** To the maximum extent permitted by applicable law, **HITACHI**, its licensors, suppliers, parent companies, affiliates, subsidiaries, employees and agents shall not under any circumstances be liable to you or any third parties for any damages of any nature arising in any way from this agreement, your use of the software or otherwise, whether indirect, special, incidental, consequential or otherwise, including, without limitation, any claims for lost profits, lost good will, lost data, business interruption, procurement of substitute goods or services, or expenditures made or committed for in reliance on the continuation of this agreement, even if advised in advance of the possibility of such damages.
8. **NO FAILURE OF ESSENTIAL PURPOSE.** You agree that neither **HITACHI'S** breach of this agreement nor its failure to repair a defect, error or bug in the software shall constitute a failure of the essential purpose of this agreement.
9. **CRYPTOGRAPHIC SOFTWARE.** The software contains software developed by the OpenSSL Project, including cryptographic software written by eric young (the "cryptographic software"). The cryptographic software is provided by the OpenSSL Project in "as is" condition and any express or implied warranties, including but not limited to, the implied warranties of merchantability and fitness for a particular purpose are hereby expressly disclaimed to the maximum extent permitted by law. In no event shall the OpenSSL Project, its contributors, **HITACHI** or any of its parent or affiliate companies be liable for any direct, indirect, incidental, special, exemplary, or consequential damages (including, but not limited to, procurement of substitute goods or services; loss of use, data, or profits; or business interruption) however caused and on any theory of liability, whether in contract, strict liability, or tort (including negligence or otherwise) arising in any way out of the use of the software or the cryptographic software, even if advised in advance of the possibility of such damages.
10. **TERMINATION.** **HITACHI** may terminate this Agreement immediately at any time by providing notice to you.
11. **GOVERNING LAW; SEVERABILITY.** This Agreement will be governed by the laws of the State of New York, and you consent to the exclusive jurisdiction and venue in the federal courts sitting in the Southern District of New York, unless no federal subject matter jurisdiction exists, in which case you consent to the exclusive jurisdiction and venue in the Borough of Manhattan, New York, USA.

End User License Agreements for Operating System Software

SOFTWARE LICENSE INFORMATION

Your **HITACHI** brand digital television (the “DTV”) uses certain open source operating system software (the “OS Software”) distributed pursuant to GNU GENERAL PUBLIC LICENSE Version 2 and GNU LESSER GENERAL PUBLIC LICENSE Version 2.1, each as defined and published by the Free Software Foundation, Inc.

The OS Software modules incorporated into the DTV are listed in the table below opposite the applicable GNU software license. Copies of such GNU software licenses are provided in the pages that follow.

Software Module	Applicable GNU Software License
Linux Kernal busybox dhcpcdd ifupdown net-tool iptables libstdc++5	GNU GENERAL PUBLIC LICENSE Version 2
glibc libposixtime	GNU LESSER GENERAL PUBLIC LICENSE Version 2.1

For purposes of incorporating the OS Software into the DTV, Hitachi made certain modifications to the source code of the OS Software (collectively, the “Source Code Modifications”) in 2006. The Source Code Modifications also are distributed pursuant to the applicable GNU software licenses identified above.

THE OS SOFTWARE AND THE SOURCE CODE MODIFICATIONS ARE PROVIDED “AS IS” AND THE LICENSEE DISCLAIMS ANY AND ALL WARRANTIES OF ANY KIND, INCLUDING THE IMPLIED WARRANTY OF MERCHANTABILITY OR FITNESS FOR A PARTICULAR PURPOSE. See the GNU General Public License for additional terms and conditions.

If you would like to learn more about the Free Software Foundation or the GNU software project, please visit <http://www.fsf.org>. If you would like to request a copy of the Source Code Modifications from **HITACHI**, please send an email to the following address: tvsoftwaresupport@hhea.hitachi.com

End User License Agreement for Operating System Software

GNU GENERAL PUBLIC LICENSE Version 2, June 1991

Copyright © 1989, 1991 Free Software Foundation, Inc.

51 Franklin St, Fifth Floor, Boston, MA 02110-1301 USA

Everyone is permitted to copy and distribute verbatim copies of this license document, but changing it is not allowed.

Preamble

The licenses for most software are designed to take away your freedom to share and change it. By contrast, the GNU General Public License is intended to guarantee your freedom to share and change free software—to make sure the software is free for all its users. This General Public License applies to most of the Free Software Foundation's software and to any other program whose authors commit to using it. (Some other Free Software Foundation software is covered by the GNU Library General Public License instead.) You can apply it to your programs, too.

When we speak of free software, we are referring to freedom, not price. Our General Public Licenses are designed to make sure that you have the freedom to distribute copies of free software (and charge for this service if you wish), that you receive source code or can get it if you want it, that you can change the software or use pieces of it in new free programs; and that you know you can do these things.

To protect your rights, we need to make restrictions that forbid anyone to deny you these rights or to ask you to surrender the rights. These restrictions translate to certain responsibilities for you if you distribute copies of the software, or if you modify it.

For example, if you distribute copies of such a program, whether gratis or for a fee, you must give the recipients all the rights that you have. You must make sure that they, too, receive or can get the source code. And you must show them these terms so they know their rights.

We protect your rights with two steps: (1) copyright the software, and (2) offer you this license which gives you legal permission to copy, distribute and/or modify the software.

Also, for each author's protection and ours, we want to make certain that everyone understands that there is no warranty for this free software. If the software is modified by someone else and passed on, we want its recipients to know that what they have is not the original, so that any problems introduced by others will not reflect on the original authors' reputations.

Finally, any free program is threatened constantly by software patents. We wish to avoid the danger that redistributors of a free program will individually obtain patent licenses, in effect making the program proprietary. To prevent this, we have made it clear that any patent must be licensed for everyone's free use or not licensed at all.

The precise terms and conditions for copying, distribution and modification follow.

GNU GENERAL PUBLIC LICENSE TERMS AND CONDITIONS FOR COPYING, DISTRIBUTION AND MODIFICATION

0. This License applies to any program or other work which contains a notice placed by the copyright holder saying it may be distributed under the terms of this General Public License. The "Program", below, refers to any such program or work, and a "work based on the Program" means either the Program or any derivative work under copyright law: that is to say, a work containing the Program or a portion of it, either verbatim or with modifications and/or translated into another language.

(Hereinafter, translation is included without limitation in the term "modification".) Each licensee is addressed as "you".

Activities other than copying, distribution and modification are not covered by this License; they are outside its scope. The act of running the Program is not restricted, and the output from the Program is covered only if its contents constitute a work based on the Program (independent of having been made by running the Program). Whether that is true depends on what the Program does.

1. You may copy and distribute verbatim copies of the Program's source code as you receive it, in any medium, provided that you conspicuously and appropriately publish on each copy an appropriate copyright notice and disclaimer of warranty; keep intact all the notices that refer to this License and to the absence of any warranty; and give any other recipients of the Program a copy of this License along with the Program.

You may charge a fee for the physical act of transferring a copy, and you may at your option offer warranty protection in exchange for a fee.

2. You may modify your copy or copies of the Program or any portion of it, thus forming a work based on the Program, and copy and distribute such modifications or work under the terms of Section 1 above, provided that you also meet all of these conditions:

- a) You must cause the modified files to carry prominent notices stating that you changed the files and the date of any change.
- b) You must cause any work that you distribute or publish, that in whole or in part contains or is derived from the Program or any part thereof, to be licensed as a whole at no charge to all third parties under the terms of this License.
- c) If the modified program normally reads commands interactively when run, you must cause it, when started running for such interactive use in the most ordinary way, to print or display an announcement including an appropriate copyright notice and a notice that there is no warranty (or else, saying that you provide a warranty) and that users may redistribute the program under these conditions, and telling the user how to view a copy of this License. (Exception: if the Program itself is interactive but does not normally print such an announcement, your work based on the Program is not required to print an announcement.)

These requirements apply to the modified work as a whole. If identifiable sections of that work are not derived from the Program, and can be reasonably considered independent and separate works in themselves, then this License, and its terms, do not apply to those sections when you distribute them as separate works. But when you distribute the same sections as part of a whole which is a work based on the Program, the distribution of the whole must be on the terms of this License, whose permissions for other licensees extend to the entire whole, and thus to each and every part regardless of who wrote it.

Thus, it is not the intent of this section to claim rights or contest your rights to work written entirely by you; rather, the intent is to exercise the right to control the distribution of derivative or collective works based on the Program.

End User License Agreement for Operating System Software

In addition, mere aggregation of another work not based on the Program with the Program (or with a work based on the Program) on a volume of a storage or distribution medium does not bring the other work under the scope of this License.

3. You may copy and distribute the Program (or a work based on it, under Section 2) in object code or executable form under the terms of Sections 1 and 2 above provided that you also do one of the following:

- a) Accompany it with the complete corresponding machine-readable source code, which must be distributed under the terms of Sections 1 and 2 above on a medium customarily used for software interchange; or,
- b) Accompany it with a written offer, valid for at least three years, to give any third party, for a charge no more than your cost of physically performing source distribution, a complete machine-readable copy of the corresponding source code, to be distributed under the terms of Sections 1 and 2 above on a medium customarily used for software interchange; or,
- c) Accompany it with the information you received as to the offer to distribute corresponding source code. (This alternative is allowed only for noncommercial distribution and only if you received the program in object code or executable form with such an offer, in accord with Subsection b above.)

The source code for a work means the preferred form of the work for making modifications to it. For an executable work, complete source code means all the source code for all modules it contains, plus any associated interface definition files, plus the scripts used to control compilation and installation of the executable. However, as a special exception, the source code distributed need not include anything that is normally distributed (in either source or binary form) with the major components (compiler, kernel, and so on) of the operating system on which the executable runs, unless that component itself accompanies the executable.

If distribution of executable or object code is made by offering access to copy from a designated place, then offering equivalent access to copy the source code from the same place counts as distribution of the source code, even though third parties are not compelled to copy the source along with the object code.

4. You may not copy, modify, sublicense, or distribute the Program except as expressly provided under this License. Any attempt otherwise to copy, modify, sublicense or distribute the Program is void, and will automatically terminate your rights under this License. However, parties who have received copies, or rights, from you under this License will not have their licenses terminated so long as such parties remain in full compliance.

5. You are not required to accept this License, since you have not signed it. However, nothing else grants you permission to modify or distribute the Program or its derivative works. These actions are prohibited by law if you do not accept this License. Therefore, by modifying or distributing the Program (or any work based on the Program), you indicate your acceptance of this License to do so, and all its terms and conditions for copying, distributing or modifying the Program or works based on it.

6. Each time you redistribute the Program (or any work based on the Program), the recipient automatically receives a license from the original licensor to copy, distribute or modify the Program subject to these terms and conditions. You may not impose any further restrictions on the recipients' exercise of the rights granted herein. You are not responsible for enforcing compliance by third parties to this License.

7. If, as a consequence of a court judgment or allegation of patent infringement or for any other reason (not limited to patent issues), conditions are imposed on you (whether by court order, agreement or otherwise) that contradict the conditions of this License, they do not excuse you from the conditions of this License. If you cannot distribute so as to satisfy simultaneously your obligations under this License and any other pertinent obligations, then as a consequence you may not distribute the Program at all.

For example, if a patent license would not permit royalty-free redistribution of the Program by all those who receive copies directly or indirectly through you, then the only way you could satisfy both it and this License would be to refrain entirely from distribution of the Program. If any portion of this section is held invalid or unenforceable under any particular circumstance, the balance of the section is intended to apply and the section as a whole is intended to apply in other circumstances.

It is not the purpose of this section to induce you to infringe any patents or other property right claims or to contest validity of any such claims; this section has the sole purpose of protecting the integrity of the free software distribution system, which is implemented by public license practices. Many people have made generous contributions to the wide range of software distributed through that system in reliance on consistent application of that system; it is up to the author/donor to decide if he or she is willing to distribute software through any other system and a licensee cannot impose that choice.

This section is intended to make thoroughly clear what is believed to be a consequence of the rest of this License.

8. If the distribution and/or use of the Program is restricted in certain countries either by patents or by copyrighted interfaces, the original copyright holder who places the Program under this License may add an explicit geographical distribution limitation excluding those countries, so that distribution is permitted only in or among countries not thus excluded. In such case, this License incorporates the limitation as if written in the body of this License.

9. The Free Software Foundation may publish revised and/or new versions of the General Public License from time to time. Such new versions will be similar in spirit to the present version, but may differ in detail to address new problems or concerns.

Each version is given a distinguishing version number. If the Program specifies a version number of this License which applies to it and "any later version", you have the option of following the terms and conditions either of that version or of any later version published by the Free Software Foundation. If the Program does not specify a version number of this License, you may choose any version ever published by the Free Software Foundation.

10. If you wish to incorporate parts of the Program into other free programs whose distribution conditions are different, write to the author to ask for permission. For software which is copyrighted by the Free Software Foundation, write to the Free Software Foundation; we sometimes make exceptions for this. Our decision will be guided by the two goals of preserving the free status of all derivatives of our free software and of promoting the sharing and reuse of software generally.

NO WARRANTY

11. BECAUSE THE PROGRAM IS LICENSED FREE OF CHARGE, THERE IS NO WARRANTY FOR THE PROGRAM, TO THE EXTENT PERMITTED BY APPLICABLE LAW. EXCEPT WHEN OTHERWISE STATED IN WRITING THE COPYRIGHT HOLDERS AND/OR OTHER PARTIES PROVIDE THE PROGRAM "AS IS" WITHOUT WARRANTY OF ANY KIND, EITHER EXPRESSED OR IMPLIED, INCLUDING, BUT NOT LIMITED

End User License Agreement for Operating System Software

TO, THE IMPLIED WARRANTIES OF MERCHANTABILITY AND FITNESS FOR A PARTICULAR PURPOSE. THE ENTIRE RISK AS TO THE QUALITY AND PERFORMANCE OF THE PROGRAM IS WITH YOU. SHOULD THE PROGRAM PROVE DEFECTIVE, YOU ASSUME THE COST OF ALL NECESSARY SERVICING, REPAIR OR CORRECTION.

12. IN NO EVENT UNLESS REQUIRED BY APPLICABLE LAW OR AGREED TO IN WRITING WILL ANY COPYRIGHT HOLDER, OR ANY OTHER PARTY WHO MAY MODIFY AND/OR REDISTRIBUTE THE PROGRAM AS PERMITTED ABOVE, BE LIABLE TO YOU FOR DAMAGES, INCLUDING ANY GENERAL, SPECIAL, INCIDENTAL OR CONSEQUENTIAL DAMAGES ARISING OUT OF THE USE OR INABILITY TO USE THE PROGRAM (INCLUDING BUT NOT LIMITED TO LOSS OF DATA OR DATA BEING RENDERED INACCURATE OR LOSSES SUSTAINED BY YOU OR THIRD PARTIES OR A FAILURE OF THE PROGRAM TO OPERATE WITH ANY OTHER PROGRAMS), EVEN IF SUCH HOLDER OR OTHER PARTY HAS BEEN ADVISED OF THE POSSIBILITY OF SUCH DAMAGES.

END OF TERMS AND CONDITIONS

How to Apply These Terms to Your New Programs

If you develop a new program, and you want it to be of the greatest possible use to the public, the best way to achieve this is to make it free software which everyone can redistribute and change under these terms.

To do so, attach the following notices to the program. It is safest to attach them to the start of each source file to most effectively convey the exclusion of warranty; and each file should have at least the "copyright" line and a pointer to where the full notice is found.

```
<one line to give the program's name and a brief idea of what it does.>
Copyright © <year> <name of author>
```

This program is free software; you can redistribute it and/or modify it under the terms of the GNU General Public License as published by the Free Software Foundation; either version 2 of the License, or (at your option) any later version.

This program is distributed in the hope that it will be useful, but WITHOUT ANY WARRANTY; without even the implied warranty of MERCHANTABILITY or FITNESS FOR A PARTICULAR PURPOSE. See the GNU General Public License for more details.

You should have received a copy of the GNU General Public License along with this program; if not, write to the Free Software Foundation, Inc., 51 Franklin St, Fifth Floor, Boston, MA 02110-1301 USA

Also add information on how to contact you by electronic and paper mail.

If the program is interactive, make it output a short notice like this when it starts in an interactive mode:

```
Gnomovision version 69, Copyright © year name of author
Gnomovision comes with ABSOLUTELY NO WARRANTY;
for details type `show w'. This is free software, and you are
welcome to redistribute it under certain conditions; type `show
c' for details.
```

The hypothetical commands `show w' and `show c' should show the appropriate parts of the General Public License. Of course, the commands you use may be called something other than `show w' and `show c'; they could even be mouse-clicks or menu items--whatever suits your program.

You should also get your employer (if you work as a programmer) or your school, if any, to sign a "copyright disclaimer" for the program, if necessary. Here is a sample; alter the names:

Yoyodyne, Inc., hereby disclaims all copyright interest in the program `Gnomovision' (which makes passes at compilers) written by James Hacker.

<signature of Ty Coon>, 1 April 1989
Ty Coon, President of Vice

This General Public License does not permit incorporating your program into proprietary programs. If your program is a subroutine library, you may consider it more useful to permit linking proprietary applications with the library. If this is what you want to do, use the GNU Library General Public License instead of this License.

End User License Agreement for Operating System Software

GNU LESSER GENERAL PUBLIC LICENSE Version 2.1, February 1999

Copyright © 1991, 1999 Free Software Foundation, Inc. 51 Franklin St, Fifth Floor, Boston, MA 02110-1301 USA
Everyone is permitted to copy and distribute verbatim copies of this license document, but changing it is not allowed.

[This is the first released version of the Lesser GPL. It also counts as the successor of the GNU Library Public License, version 2, hence the version number 2.1.]

Preamble

The licenses for most software are designed to take away your freedom to share and change it. By contrast, the GNU General Public Licenses are intended to guarantee your freedom to share and change free software--to make sure the software is free for all its users.

This license, the Lesser General Public License, applies to some specially designated software packages--typically libraries--of the Free Software Foundation and other authors who decide to use it. You can use it too, but we suggest you first think carefully about whether this license or the ordinary General Public License is the better strategy to use in any particular case, based on the explanations below.

When we speak of free software, we are referring to freedom of use, not price. Our General Public Licenses are designed to make sure that you have the freedom to distribute copies of free software (and charge for this service if you wish); that you receive source code or can get it if you want it; that you can change the software and use pieces of it in new free programs; and that you are informed that you can do these things.

To protect your rights, we need to make restrictions that forbid distributors to deny you these rights or to ask you to surrender these rights. These restrictions translate to certain responsibilities for you if you distribute copies of the library or if you modify it.

For example, if you distribute copies of the library, whether gratis or for a fee, you must give the recipients all the rights that we gave you. You must make sure that they, too, receive or can get the source code. If you link other code with the library, you must provide complete object files to the recipients, so that they can relink them with the library after making changes to the library and recompiling it. And you must show them these terms so they know their rights.

We protect your rights with a two-step method: (1) we copyright the library, and (2) we offer you this license, which gives you legal permission to copy, distribute and/or modify the library.

To protect each distributor, we want to make it very clear that there is no warranty for the free library. Also, if the library is modified by someone else and passed on, the recipients should know that what they have is not the original version, so that the original author's reputation will not be affected by problems that might be introduced by others.

Finally, software patents pose a constant threat to the existence of any free program. We wish to make sure that a company cannot effectively restrict the users of a free program by obtaining a restrictive license from a patent holder. Therefore, we insist that any patent license obtained for a version of the library must be consistent with the full freedom of use specified in this license.

Most GNU software, including some libraries, is covered by the ordinary GNU General Public License. This license, the GNU Lesser General Public License, applies to certain designated libraries, and is quite different from the ordinary General Public License. We use this license for certain libraries in order to permit linking those libraries into non-free programs.

When a program is linked with a library, whether statically or using a shared library, the combination of the two is legally speaking a combined work, a derivative of the original library. The ordinary General Public License therefore permits such linking only if the entire combination fits its criteria of freedom. The Lesser General Public License permits more lax criteria for linking other code with the library.

We call this license the "Lesser" General Public License because it does Less to protect the user's freedom than the ordinary General Public License. It also provides other free software developers Less of an advantage over competing non-free programs. These disadvantages are the reason we use the ordinary General Public License for many libraries. However, the Lesser license provides advantages in certain special circumstances.

For example, on rare occasions, there may be a special need to encourage the widest possible use of a certain library, so that it becomes a de-facto standard. To achieve this, non-free programs must be allowed to use the library. A more frequent case is that a free library does the same job as widely used non-free libraries. In this case, there is little to gain by limiting the free library to free software only, so we use the Lesser General Public License.

In other cases, permission to use a particular library in non-free programs enables a greater number of people to use a large body of free software. For example, permission to use the GNU C Library in non-free programs enables many more people to use the whole GNU operating system, as well as its variant, the GNU/Linux operating system.

Although the Lesser General Public License is Less protective of the users' freedom, it does ensure that the user of a program that is linked with the Library has the freedom and the wherewithal to run that program using a modified version of the Library.

The precise terms and conditions for copying, distribution and modification follow. Pay close attention to the difference between a "work based on the library" and a "work that uses the library". The former contains code derived from the library, whereas the latter must be combined with the library in order to run.

GNU LESSER GENERAL PUBLIC LICENSE TERMS AND CONDITIONS FOR COPYING, DISTRIBUTION AND MODIFICATION

0. This License Agreement applies to any software library or other program which contains a notice placed by the copyright holder or other authorized party saying it may be distributed under the terms of this Lesser General Public License (also called "this License"). Each licensee is addressed as "you".

A "library" means a collection of software functions and/or data prepared so as to be conveniently linked with application programs (which use some of those functions and data) to form executables.

The "Library", below, refers to any such software library or work which has been distributed under these terms. A "work based on the Library" means either the Library or any derivative work under copyright law: that is to say, a work containing the Library or a portion of it, either verbatim or with modifications and/or translated

End User License Agreement for Operating System Software

straightforwardly into another language. (Hereinafter, translation is included without limitation in the term "modification".)

"Source code" for a work means the preferred form of the work for making modifications to it. For a library, complete source code means all the source code for all modules it contains, plus any associated interface definition files, plus the scripts used to control compilation and installation of the library.

Activities other than copying, distribution and modification are not covered by this License; they are outside its scope. The act of running a program using the Library is not restricted, and output from such a program is covered only if its contents constitute a work based on the Library (independent of the use of the Library in a tool for writing it). Whether that is true depends on what the Library does and what the program that uses the Library does.

1. You may copy and distribute verbatim copies of the Library's complete source code as you receive it, in any medium, provided that you conspicuously and appropriately publish on each copy an appropriate copyright notice and disclaimer of warranty; keep intact all the notices that refer to this License and to the absence of any warranty; and distribute a copy of this License along with the Library.

You may charge a fee for the physical act of transferring a copy, and you may at your option offer warranty protection in exchange for a fee.

2. You may modify your copy or copies of the Library or any portion of it, thus forming a work based on the Library, and copy and distribute such modifications or work under the terms of Section 1 above, provided that you also meet all of these conditions:

- a) The modified work must itself be a software library.
- b) You must cause the files modified to carry prominent notices stating that you changed the files and the date of any change.
- c) You must cause the whole of the work to be licensed at no charge to all third parties under the terms of this License.
- d) If a facility in the modified Library refers to a function or a table of data to be supplied by an application program that uses the facility, other than as an argument passed when the facility is invoked, then you must make a good faith effort to ensure that, in the event an application does not supply such function or table, the facility still operates, and performs whatever part of its purpose remains meaningful. (For example, a function in a library to compute square roots has a purpose that is entirely well-defined independent of the application. Therefore, Subsection 2d requires that any application-supplied function or table used by this function must be optional: if the application does not supply it, the square root function must still compute square roots.)

These requirements apply to the modified work as a whole. If identifiable sections of that work are not derived from the Library, and can be reasonably considered independent and separate works in themselves, then this License, and its terms, do not apply to those sections when you distribute them as separate works. But when you distribute the same sections as part of a whole which is a work based on the Library, the distribution of the whole must be on the terms of this License, whose permissions for other licensees extend to the entire whole, and thus to each and every part regardless of who wrote it.

Thus, it is not the intent of this section to claim rights or contest your rights to work written entirely by you; rather, the intent is

to exercise the right to control the distribution of derivative or collective works based on the Library.

In addition, mere aggregation of another work not based on the Library with the Library (or with a work based on the Library) on a volume of a storage or distribution medium does not bring the other work under the scope of this License.

3. You may opt to apply the terms of the ordinary GNU General Public License instead of this License to a given copy of the Library. To do this, you must alter all the notices that refer to this License, so that they refer to the ordinary GNU General Public License, version 2, instead of to this License. (If a newer version than version 2 of the ordinary GNU General Public License has appeared, then you can specify that version instead if you wish.) Do not make any other change in these notices.

Once this change is made in a given copy, it is irreversible for that copy, so the ordinary GNU General Public License applies to all subsequent copies and derivative works made from that copy.

This option is useful when you wish to copy part of the code of the Library into a program that is not a library.

4. You may copy and distribute the Library (or a portion or derivative of it, under Section 2) in object code or executable form under the terms of Sections 1 and 2 above provided that you accompany it with the complete corresponding machine-readable source code, which must be distributed under the terms of Sections 1 and 2 above on a medium customarily used for software interchange.

If distribution of object code is made by offering access to copy from a designated place, then offering equivalent access to copy the source code from the same place satisfies the requirement to distribute the source code, even though third parties are not compelled to copy the source along with the object code.

5. A program that contains no derivative of any portion of the Library, but is designed to work with the Library by being compiled or linked with it, is called a "work that uses the Library". Such a work, in isolation, is not a derivative work of the Library, and therefore falls outside the scope of this License.

However, linking a "work that uses the Library" with the Library creates an executable that is a derivative of the Library (because it contains portions of the Library), rather than a "work that uses the library". The executable is therefore covered by this License. Section 6 states terms for distribution of such executables.

When a "work that uses the Library" uses material from a header file that is part of the Library, the object code for the work may be a derivative work of the Library even though the source code is not. Whether this is true is especially significant if the work can be linked without the Library, or if the work is itself a library. The threshold for this to be true is not precisely defined by law.

If such an object file uses only numerical parameters, data structure layouts and accessors, and small macros and small inline functions (ten lines or less in length), then the use of the object file is unrestricted, regardless of whether it is legally a derivative work. (Executables containing this object code plus portions of the Library will still fall under Section 6.)

Otherwise, if the work is a derivative of the Library, you may distribute the object code for the work under the terms of Section 6. Any executables containing that work also fall under Section 6, whether or not they are linked directly with the Library itself.

6. As an exception to the Sections above, you may also combine or link a "work that uses the Library" with the Library to produce

End User License Agreement for Operating System Software

a work containing portions of the Library, and distribute that work under terms of your choice, provided that the terms permit modification of the work for the customer's own use and reverse engineering for debugging such modifications.

You must give prominent notice with each copy of the work that the Library is used in it and that the Library and its use are covered by this License. You must supply a copy of this License. If the work during execution displays copyright notices, you must include the copyright notice for the Library among them, as well as a reference directing the user to the copy of this License. Also, you must do one of these things:

- a) Accompany the work with the complete corresponding machine-readable source code for the Library including whatever changes were used in the work (which must be distributed under Sections 1 and 2 above); and, if the work is an executable linked with the Library, with the complete machine-readable "work that uses the Library", as object code and/or source code, so that the user can modify the Library and then relink to produce a modified executable containing the modified Library. (It is understood that the user who changes the contents of definitions files in the Library will not necessarily be able to recompile the application to use the modified definitions.)
- b) Use a suitable shared library mechanism for linking with the Library. A suitable mechanism is one that (1) uses at run time a copy of the library already present on the user's computer system, rather than copying library functions into the executable, and (2) will operate properly with a modified version of the library, if the user installs one, as long as the modified version is interface-compatible with the version that the work was made with.
- c) Accompany the work with a written offer, valid for at least three years, to give the same user the materials specified in Subsection 6a, above, for a charge no more than the cost of performing this distribution.
- d) If distribution of the work is made by offering access to copy from a designated place, offer equivalent access to copy the above specified materials from the same place.
- e) Verify that the user has already received a copy of these materials or that you have already sent this user a copy.

For an executable, the required form of the "work that uses the Library" must include any data and utility programs needed for reproducing the executable from it. However, as a special exception, the materials to be distributed need not include anything that is normally distributed (in either source or binary form) with the major components (compiler, kernel, and so on) of the operating system on which the executable runs, unless that component itself accompanies the executable.

It may happen that this requirement contradicts the license restrictions of other proprietary libraries that do not normally accompany the operating system. Such a contradiction means you cannot use both them and the Library together in an executable that you distribute.

7. You may place library facilities that are a work based on the Library side-by-side in a single library together with other library facilities not covered by this License, and distribute such a combined library, provided that the separate distribution of the work based on the Library and of the other library facilities is otherwise permitted, and provided that you do these two things:

- a) Accompany the combined library with a copy of the same work based on the Library, uncombined with any other library facilities. This must be distributed under the terms of

the Sections above.

- b) Give prominent notice with the combined library of the fact that part of it is a work based on the Library, and explaining where to find the accompanying uncombined form of the same work.

8. You may not copy, modify, sublicense, link with, or distribute the Library except as expressly provided under this License. Any attempt otherwise to copy, modify, sublicense, link with, or distribute the Library is void, and will automatically terminate your rights under this License. However, parties who have received copies, or rights, from you under this License will not have their licenses terminated so long as such parties remain in full compliance.

9. You are not required to accept this License, since you have not signed it. However, nothing else grants you permission to modify or distribute the Library or its derivative works. These actions are prohibited by law if you do not accept this License. Therefore, by modifying or distributing the Library (or any work based on the Library), you indicate your acceptance of this License to do so, and all its terms and conditions for copying, distributing or modifying the Library or works based on it.

10. Each time you redistribute the Library (or any work based on the Library), the recipient automatically receives a license from the original licensor to copy, distribute, link with or modify the Library subject to these terms and conditions. You may not impose any further restrictions on the recipients' exercise of the rights granted herein. You are not responsible for enforcing compliance by third parties with this License.

11. If, as a consequence of a court judgment or allegation of patent infringement or for any other reason (not limited to patent issues), conditions are imposed on you (whether by court order, agreement or otherwise) that contradict the conditions of this License, they do not excuse you from the conditions of this License. If you cannot distribute so as to satisfy simultaneously your obligations under this License and any other pertinent obligations, then as a consequence you may not distribute the Library at all. For example, if a patent license would not permit royalty-free redistribution of the Library by all those who receive copies directly or indirectly through you, then the only way you could satisfy both it and this License would be to refrain entirely from distribution of the Library.

If any portion of this section is held invalid or unenforceable under any particular circumstance, the balance of the section is intended to apply, and the section as a whole is intended to apply in other circumstances.

It is not the purpose of this section to induce you to infringe any patents or other property right claims or to contest validity of any such claims; this section has the sole purpose of protecting the integrity of the free software distribution system which is implemented by public license practices. Many people have made generous contributions to the wide range of software distributed through that system in reliance on consistent application of that system; it is up to the author/donor to decide if he or she is willing to distribute software through any other system and a licensee cannot impose that choice.

This section is intended to make thoroughly clear what is believed to be a consequence of the rest of this License.

12. If the distribution and/or use of the Library is restricted in certain countries either by patents or by copyrighted interfaces, the original copyright holder who places the Library under this License may add an explicit geographical distribution limitation excluding those countries, so that distribution is permitted only in

End User License Agreement for Operating System Software

or among countries not thus excluded. In such case, this License incorporates the limitation as if written in the body of this License.

13. The Free Software Foundation may publish revised and/or new versions of the Lesser General Public License from time to time. Such new versions will be similar in spirit to the present version, but may differ in detail to address new problems or concerns. Each version is given a distinguishing version number. If the Library specifies a version number of this License which applies to it and "any later version", you have the option of following the terms and conditions either of that version or of any later version published by the Free Software Foundation. If the Library does not specify a license version number, you may choose any version ever published by the Free Software Foundation.

14. If you wish to incorporate parts of the Library into other free programs whose distribution conditions are incompatible with these, write to the author to ask for permission. For software which is copyrighted by the Free Software Foundation, write to the Free Software Foundation; we sometimes make exceptions for this. Our decision will be guided by the two goals of preserving the free status of all derivatives of our free software and of promoting the sharing and reuse of software generally.

NO WARRANTY

15. BECAUSE THE LIBRARY IS LICENSED FREE OF CHARGE, THERE IS NO WARRANTY FOR THE LIBRARY, TO THE EXTENT PERMITTED BY APPLICABLE LAW. EXCEPT WHEN OTHERWISE STATED IN WRITING THE COPYRIGHT HOLDERS AND/OR OTHER PARTIES PROVIDE THE LIBRARY "AS IS" WITHOUT WARRANTY OF ANY KIND, EITHER EXPRESSED OR IMPLIED, INCLUDING, BUT NOT LIMITED TO, THE IMPLIED WARRANTIES OF MERCHANTABILITY AND FITNESS FOR A PARTICULAR PURPOSE. THE ENTIRE RISK AS TO THE QUALITY AND PERFORMANCE OF THE LIBRARY IS WITH YOU. SHOULD THE LIBRARY PROVE DEFECTIVE, YOU ASSUME THE COST OF ALL NECESSARY SERVICING, REPAIR OR CORRECTION.

16. IN NO EVENT UNLESS REQUIRED BY APPLICABLE LAW OR AGREED TO IN WRITING WILL ANY COPYRIGHT HOLDER, OR ANY OTHER PARTY WHO MAY MODIFY AND/OR REDISTRIBUTE THE LIBRARY AS PERMITTED ABOVE, BE LIABLE TO YOU FOR DAMAGES, INCLUDING ANY GENERAL, SPECIAL, INCIDENTAL OR CONSEQUENTIAL DAMAGES ARISING OUT OF THE USE OR INABILITY TO USE THE LIBRARY (INCLUDING BUT NOT LIMITED TO LOSS OF DATA OR DATA BEING RENDERED INACCURATE OR LOSSES SUSTAINED BY YOU OR THIRD PARTIES OR A FAILURE OF THE LIBRARY TO OPERATE WITH ANY OTHER SOFTWARE), EVEN IF SUCH HOLDER OR OTHER PARTY HAS BEEN ADVISED OF THE POSSIBILITY OF SUCH DAMAGES.

END OF TERMS AND CONDITIONS

How to Apply These Terms to Your New Libraries

If you develop a new library, and you want it to be of the greatest possible use to the public, we recommend making it free software that everyone can redistribute and change. You can do so by permitting redistribution under these terms (or, alternatively, under the terms of the ordinary General Public License).

To apply these terms, attach the following notices to the library. It is safest to attach them to the start of each source file to most effectively convey the exclusion of warranty; and each file should have at least the "copyright" line and a pointer to where the full notice is found.

<one line to give the library's name and a brief idea of what it does.>

Copyright © <year> <name of author>

This library is free software; you can redistribute it and/or modify it under the terms of the GNU Lesser General Public License as published by the Free Software Foundation; either version 2.1 of the License, or (at your option) any later version.

This library is distributed in the hope that it will be useful, but WITHOUT ANY WARRANTY; without even the implied warranty of MERCHANTABILITY or FITNESS FOR A PARTICULAR PURPOSE. See the GNU Lesser General Public License for more details.

You should have received a copy of the GNU Lesser General Public License along with this library; if not, write to the Free Software Foundation, Inc., 51 Franklin St, Fifth Floor, Boston, MA 02110-1301 USA

Also add information on how to contact you by electronic and paper mail.

You should also get your employer (if you work as a programmer) or your school, if any, to sign a "copyright disclaimer" for the library, if necessary. Here is a sample; alter the names: Yoyodyne, Inc., hereby disclaims all copyright interest in the library 'Frob' (a library for tweaking knobs) written by James Random Hacker.

<signature of Ty Coon>, 1 April 1990

Ty Coon, President of Vice

That's all there is to it!

Appendix

Appendix A:

Picture format for each input source

Aspect

(1) Auto Aspect: OFF

		Input Signal			Aspect Mode						
		Format	Aspect	Video ID HDMI Info	16:9 Standard	16:9 Zoom	4:3 Standard	4:3 Expanded	4:3 Zoom 1	4:3 Zoom 2	
ANT Analog	Video	NTSC	4x3	-	YES	YES	YES	YES	YES	YES	
ANT Digital	YPbPr	1080i	16x9	-	YES	YES	-	YES	-	-	
			4x3	-	-	-	YES	YES	YES	YES	
Input 1 Input 2	HDMI	1080i 720p 480p 480i	16x9	-	YES	YES	-	YES	-	-	
			16x9	16x9	YES	YES	YES	YES	YES	YES	
			Letter	Letter	-	-	YES	YES	YES Initial	YES	
			4x3	4x3	-	-	YES	YES	YES Initial	YES	
			-	No information	YES	YES	YES	YES	YES	YES	
	S-Video Video	NTSC	16x9 Letter 4x3 -	16x9	16x9	YES	YES	YES	YES	YES	YES
				Letter	Letter	-	-	YES	YES	YES Initial	YES
				4x3	4x3	-	-	YES	YES	YES Initial	YES
				-	No information	YES	YES	YES	YES	YES	YES
				-	No information	YES	YES	YES	YES	YES	YES
Input 3 Input 4	YPbPr	1080i 720p 480p 480i	16x9	-	YES	YES	-	YES	-	-	
			16x9	16x9	YES	YES	YES	YES	YES	YES	
			Letter	Letter	-	-	YES	YES	YES Initial	YES	
			4x3	4x3	-	-	YES	YES	YES Initial	YES	
			-	No information	YES	YES	YES	YES	YES	YES	
	Video	NTSC	16x9 Letter 4x3 -	16x9	16x9	YES	YES	YES	YES	YES	YES
				Letter	Letter	-	-	YES	YES	YES Initial	YES
				4x3	4x3	-	-	YES	YES	YES Initial	YES
				-	No information	YES	YES	YES	YES	YES	YES
				-	No information	YES	YES	YES	YES	YES	YES
Input 5	Same as above										
Horizontal Expansion					100%	133%	75%	100%	100%	133%	
Vertical Expansion					100%	133%	100%	110%	133%	176%	

(2) Auto Aspect: ON

		Input Signal			Aspect Mode						
		Format	Aspect	Video ID HDMI Info	16:9 Standard	16:9 Zoom	4:3 Standard	4:3 Expanded	4:3 Zoom 1	4:3 Zoom 2	
ANT Analog	Video	NTSC	4x3	-	YES	YES	YES	YES	YES	YES	
ANT Digital	YPbPr	1080i	16x9	-	YES	YES	-	YES	-	-	
			4x3	-	-	-	YES	YES	YES	YES	
Input 1 Input 2	HDMI	1080i 720p 480p 480i	16x9	-	YES	YES	-	YES	-	-	
			16x9	16x9	YES Initial	YES	-	-	-	-	
			Letter	Letter	-	-	YES	YES	YES Initial	YES	
			4x3	4x3	-	-	YES	YES	YES Initial	YES	
			-	No information	YES	YES	YES	YES	YES	YES	
	S-Video Video	NTSC	16x9 Letter 4x3 -	16x9	16x9	YES Initial	YES	-	-	-	-
				Letter	Letter	-	-	YES	YES	YES Initial	YES
				4x3	4x3	-	-	YES	YES	YES Initial	YES
				-	No information	YES	YES	YES	YES	YES	YES
				-	No information	YES	YES	YES	YES	YES	YES
Input 3 Input 4	YPbPr	1080i 720p 480p 480i	16x9	-	YES	YES	-	YES	-	-	
			16x9	16x9	YES Initial	YES	-	-	-	-	
			Letter	Letter	-	-	YES	YES	YES Initial	YES	
			4x3	4x3	-	-	YES	YES	YES Initial	YES	
			-	No information	YES	YES	YES	YES	YES	YES	
	Video	NTSC	16x9 Letter 4x3 -	16x9	16x9	YES Initial	YES	-	-	-	-
				Letter	Letter	-	-	YES	YES	YES Initial	YES
				4x3	4x3	-	-	YES	YES	YES Initial	YES
				-	No information	YES	YES	YES	YES	YES	YES
				-	No information	YES	YES	YES	YES	YES	YES
Input 5	Same as above										
Horizontal Expansion					100%	133%	75%	100%	100%	133%	
Vertical Expansion					100%	133%	100%	110%	133%	176%	

A	TV Ratings (Canadian - French)	44
	Alternate Ratings U.S.	45
Accessories,		4
Antennas (Connecting),		7
Aspect Ratio,		21, 34
Audio		
Bass Boost		36
Audio Settings		36
Audio Source		37
Auto Noise Cancel		37
B		
Balance		36
Bass		36
Black Enhancement		34
Black Side Panel		35
Brightness		33
C		
CableCARD		12
Caution and Safety Tips		2-3
Channel Manager		38-39
Auto Channel Scan		38
Clock		46
Closed Captions		
Captions		52
Color Temperature		34
Color		33
Contrast		33
Contrast Mode		34
E		
Event Timer		48
External Video Source		12-18
F		
Favorite Channel		23
Freeze		20,26
H		
HDMI		13,16
I		
Input Setup		22,51
L		
Lamp Replacement.		56-59
Language		
Menu Language		49
Locks		
Change Access Code		40
Channel Lock		40
Front Panel Lock		40
Movie Ratings		41
TV Ratings		42
TV Ratings (Canadian - English)		43
M		
Menu Options		
Language		49
Background		50
Monitor Out		53
N		
Noise Reduction		34
P		
Perfect Volume		37
Picture Mode		33
Picture-in-Picture (PIP)		24-26
R		
Remote Control		
Functions		19-23
Programming Codes		27-30
Installing Batteries		4
S		
Sharpness		33
Speakers		37
Connecting External Speakers		37
Internal		37
Split Mode		24
Surround		36
T		
Timers		46-48
Tint		33
Treble		36
V		
Video Settings		33-35

Service Information

When you call HITACHI SERVICE HOTLINE they will require some information related to the TV MODEL NAME and SERIAL # in order to give you the proper support. This information is located on the back of the TV and also on the RIGHT SIDE of your TV set. Please follow the next steps to find this information and then provide to SERVICE.

- 1 Look on the right side of the TV.
- 2 Locate the LABEL where it shows the information related to MODEL NAME and SERIAL #.
- 3 HITACHI Service Department will require this information in order to give you the proper support regarding your questions.

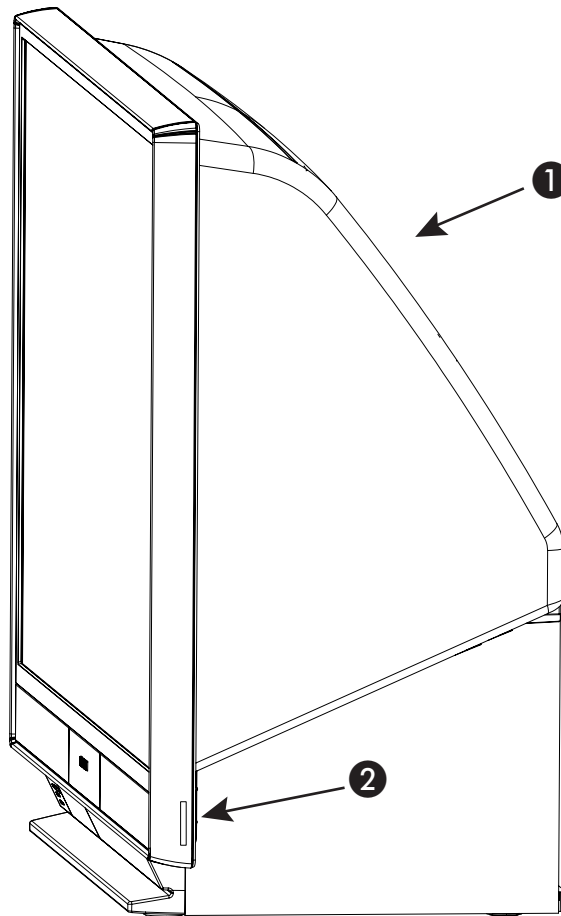

Notes

HITACHI

Inspire the Next